

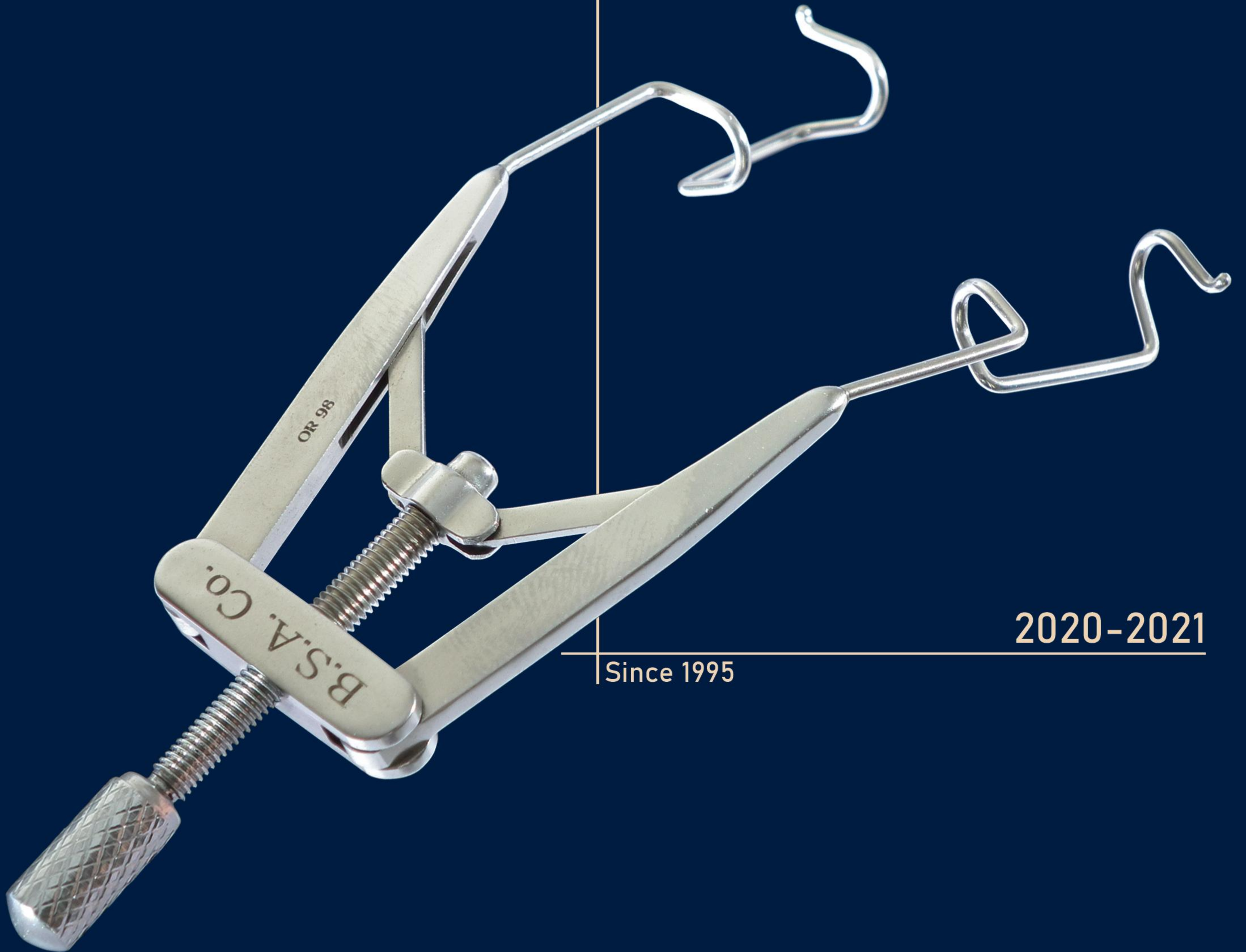

BINA SAZ ABZAR



2020-2021

Since 1995

## درباره ما

شرکت بینا ساز ابزار در سال ۱۳۷۶ با هدف تولید و تعمیر ابزار جراحی چشم پزشکی با مدیریت سید رضا هزاوه تأسیس گردیده است.

این شرکت توانست با تکیه بر دانش متخصصان چشم پزشک و فعالیت های شبانه روزی پرسنل خود و با حداقل امکانات موجود، با طراحی و الگوبرداری از ابزارهای چشم پزشکی صاحب نام اروپایی و آمریکایی جای خود را در بازار پر رقابت و رو به رشد ابزار جراحی چشم پزشکی به عنوان نخستین و تنها تولید کننده ابزار تخصصی چشم پزشکی در ایران باز نماید.

با دریافت مجوزهای مربوطه مانند پروانه ساخت اداره کل تجهیزات پزشکی و گواهینامه ISO 13485:2016 و گذشت قریب به ۲۵ سال از اولین تولید این شرکت مفتخریم تا با همت و تلاش یکایک پرسنل خود و استناد به گواهی نامه های اخذ شده و همچنین اتکا به گواهی اکثریت قریب به اتفاق مصرف کنندگان محصولات خود در سراسر کشور ایران و برخی کشورهای همسایه ضمن حفظ اطمینان مصرف کنندگان و مدیریت بر کیفیت محصولات تولیدی خود پا به عرصه صادرات جهانی گذاشته و بتوانیم به نوبه خود افتخار دیگری برای کشورمان ایران به ارمغان بیاوریم.

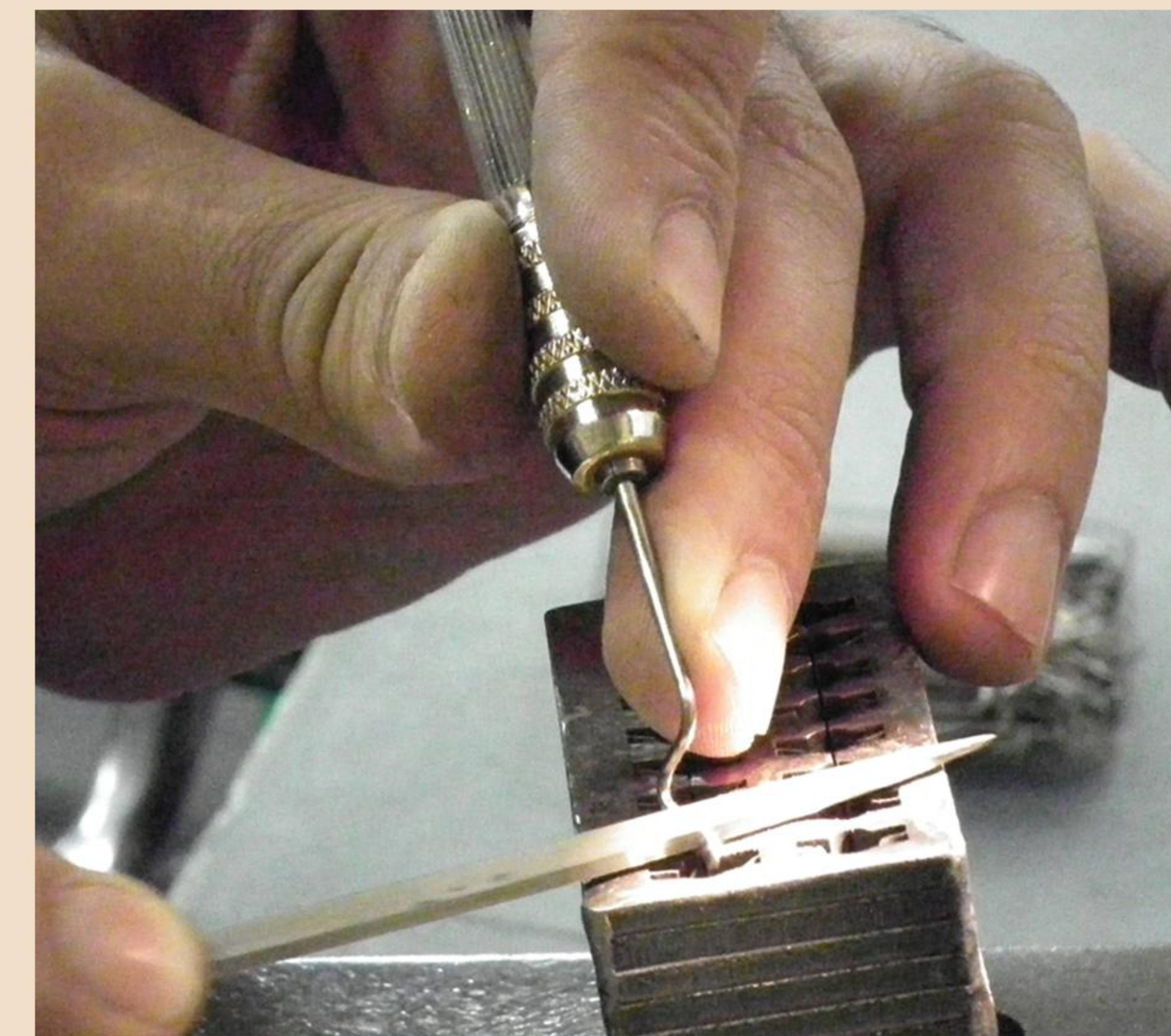
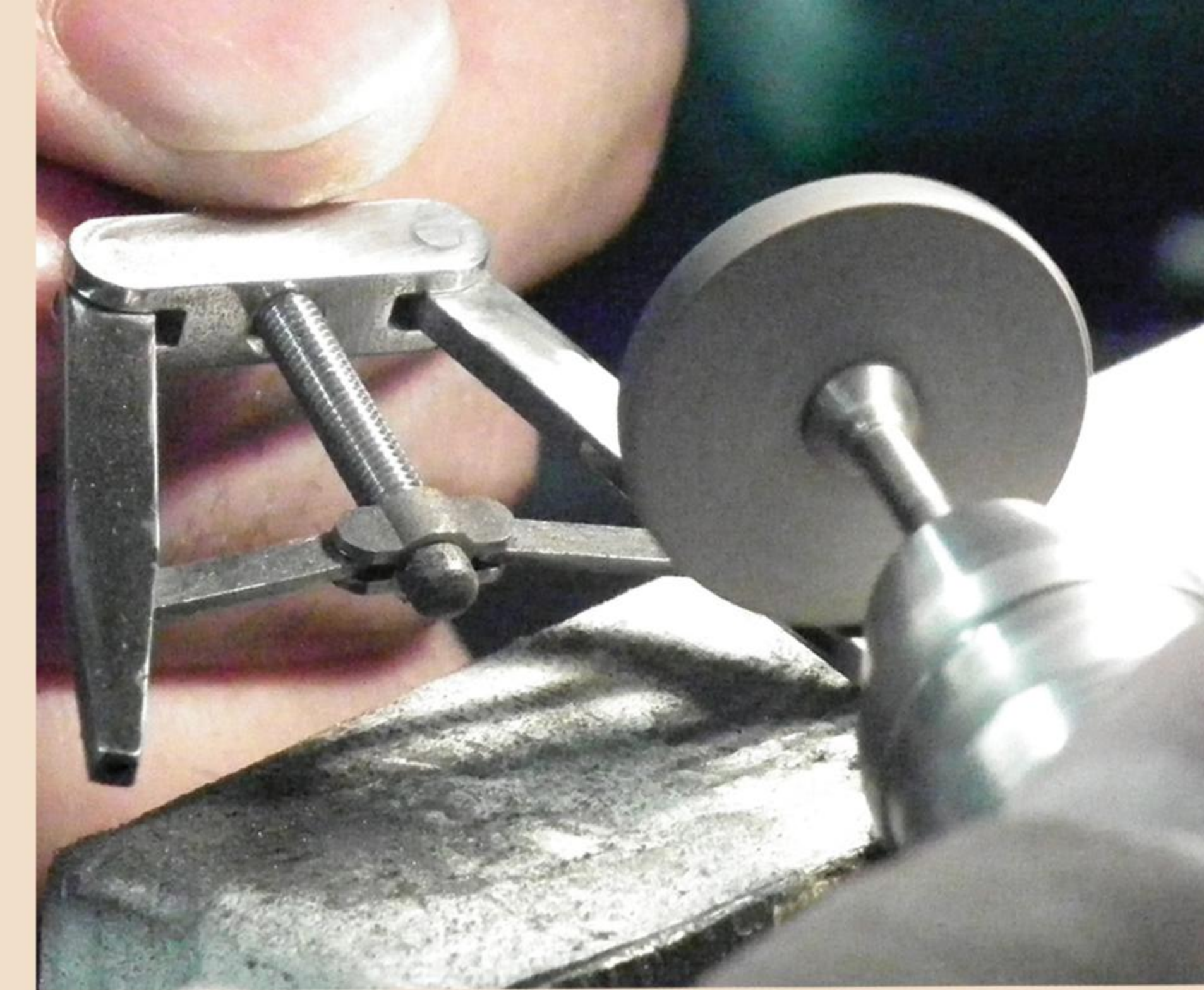

## فهرست

- |    |                        |              |    |                        |                   |
|----|------------------------|--------------|----|------------------------|-------------------|
| 01 | <u>I</u> NTRODUCTION   | درباره ما    | 39 | <u>N</u> EEDELE HOLDER | سوزنگیر           |
| 03 | <u>C</u> ANNULA        | سوزن         | 41 | <u>S</u> CISSORS       | قیچی              |
| 09 | <u>S</u> PATULA        | اسپاچولا     | 44 | <u>L</u> ID SPECULUM   | پلک باز کن        |
| 14 | <u>N</u> EW PRODUCTS   | محصولات جدید | 50 | <u>L</u> ACHRYMAL      | مجاری اشکی        |
| 16 | <u>F</u> IXATION RINGS | فیکسیشن رینگ | 53 | <u>R</u> ETINAL        | شبکیه             |
| 18 | <u>T</u> REPHINE       | ترفاین       | 56 | <u>C</u> HOPPER        | چاپر              |
| 20 | <u>H</u> OOK           | هوک          | 59 | <u>M</u> EASURING      | ابزار اندازه گیری |
| 26 | <u>R</u> ETRACTOR      | اکارتور      | 61 | <u>G</u> ENERAL        | عمومی             |
| 29 | <u>F</u> ORCEPS        | پنس و پنست   | 67 | <u>S</u> URGICAL SET   | ست جراحی          |

80 MAINTEANCE OF OPHTHALMIC SURGICAL INSTRUMENTS  
نگهداری از ابزار جراحی



Nucleus Hydro Dissection Cannula

- B#15-235 G.23
- B#15-245 G.24
- B#15-255 G.25
- B#15-265 G.26
- B#15-275 G.27



Air Injection Cannula

- B#10-230 G.23
- B#10-240 G.24
- B#10-250 G.25
- B#10-260 G.26
- B#10-270 G.27
- B#10-300 G.30



Double I & A Cannula

- J- Shaped
- B#20-116



Nucleus Hydro Dissection Cannula

- B#15-270 G.27 Chung



Double I / A Cannula Reverse

- B#20-115 G.22
- B#20-135 G.23



Double I / A Cannula Original

- B#20-110 G.22
- B#20-130 G.23

# BINA® INSTRUMENTS

## CANNULA





Jensen  
Posterior Capsule Polisher  
Curved Tube  
Olive Tip With Front Opening Port  
B#10-150 G.23



Aspirating Cannula  
F#10-85 G.20  
F#10-86 G.23



Simcoe  
Cortex Extractor & Capsule Polisher  
Curved tube  
Sandblasted Tip, Port Facing Into Curve  
B#10-160 G.22, G.23



Kratz  
Posterior Extractor & Capsule Polisher  
G.23 Curved Tube  
Sandblasted Tip, Port Facing Into Curve  
B#10-170



Simcoe  
Cortex Extractor Cannula  
B#22-200 G.22  
B#22-300 G.23



Silicone Injection Cannula  
B#25-100 G.16  
B#25-118 G.18  
B#25-119 G.19



Lachrymal Irrigating Cannula  
B#40-280



Irrigating Cannula Curved  
For Lasik  
B#50-220 1 Hole G.24  
B#50-220/1 1 Hole G.24  
B#50-220/2 2 Holes G.24  
B#50-220/3 3 Holes G.24  
B#50-220/4 4 Holes G.24  
B#50-220/5 8 Holes G.24



Mc Intyre lachrymal probing Cannula  
Long Tube, Blunt Tip  
With dual 0.3mm side opening  
B#40-100 G.22 50 mm  
B#40-200 G.23 50 mm



Fluid Irrigating Cannula  
F#10-220 G.20  
F#10-221 G.21  
F#10-222 G.22



Sub Retinal Fluid Drainage  
Soft Tip  
F#10-95 G.20



**Bimanual Hand Pieces Phaco**

Hand Pieces  
F#10-150 A Aspiration Handpiece  
F#10-150 I Irrigation Handpiece  
Cannula Size: G.21



**Bimanual Hand Pieces Phaco**

Integrated  
F#10-150 A Aspiration Handpiece  
F#10-150 I Irrigation Handpiece  
Cannula Size: G.21

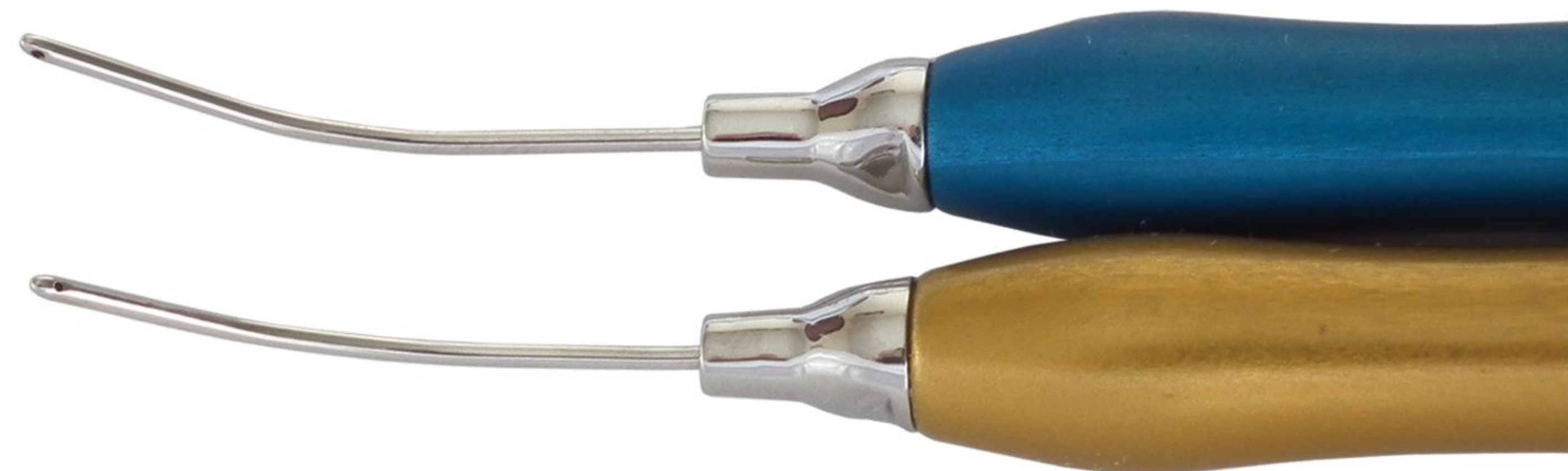

**Self-Retaining Anterior Chamber Maintainer**

B#30-300	G.20	0.9 mm
B#30-310	G.21	0.8 mm
B#30-320	G.22	0.7 mm
B#30-330	G.23	0.6 mm



**Vitrectomy Infusion Cannula**

Infusion Cannula		
B#30-200	4 mm, 6 mm	
B#30-250	2.5 mm, 4 mm, 6 mm	



**Adaptor**

Female/Male  
With 25 cm Long Silicone Tube  
F#10-155A



Iris Spatula  
Cyclodialysis  
C#10-150

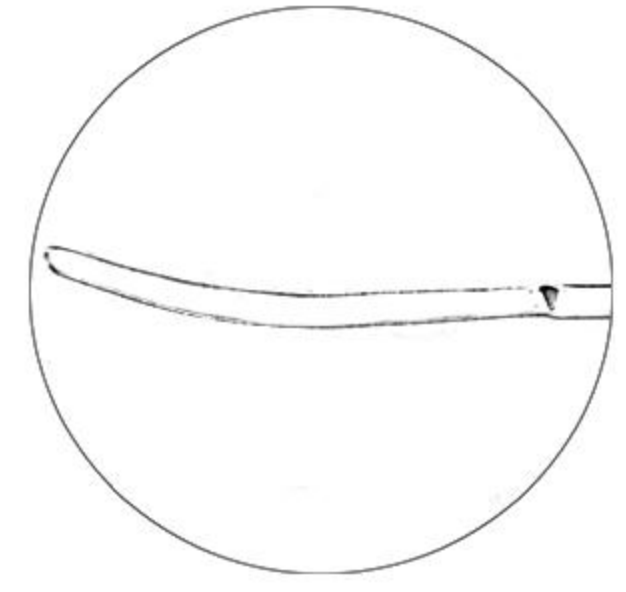

Iris Spatula  
C#10-150-1



Anwar Type Keratoplasty Spatula  
C#10-150-2

# BINA® INSTRUMENTS

## SPATULA

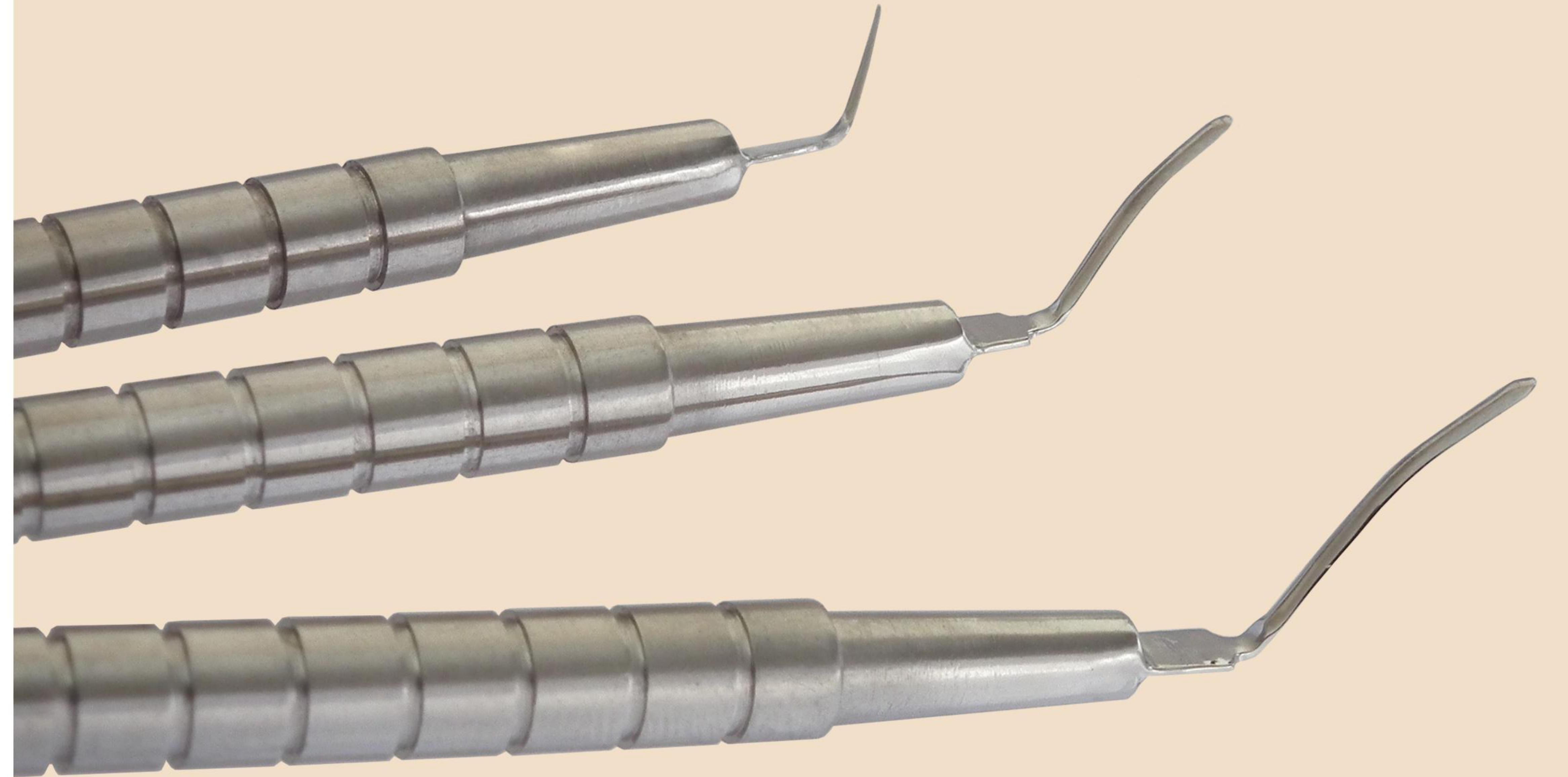



Epithelial- Detachment Spatula

Micro Hoe  
C#10-175-20

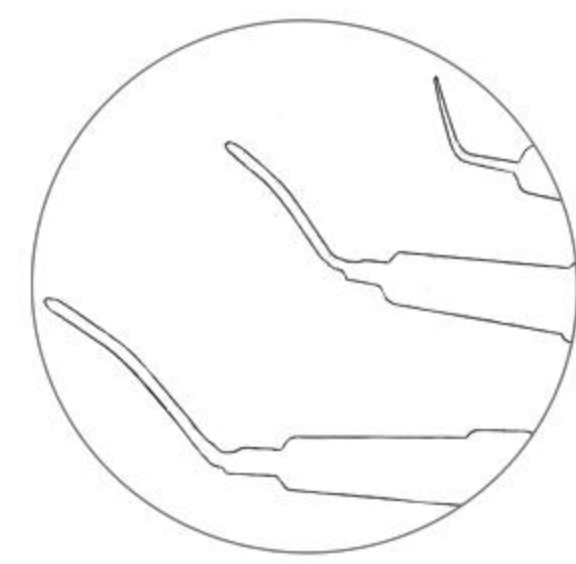

Deep Lamellar Endothelial Keratoplasty (DLEK) Spatula

Melles Type

C#10-150	Long	MG
C#10-150	Medium	MB
C#10-150	Triangle	MR



Phaco Spatula

Secondary Instrument  
Vertical  
C#10-160

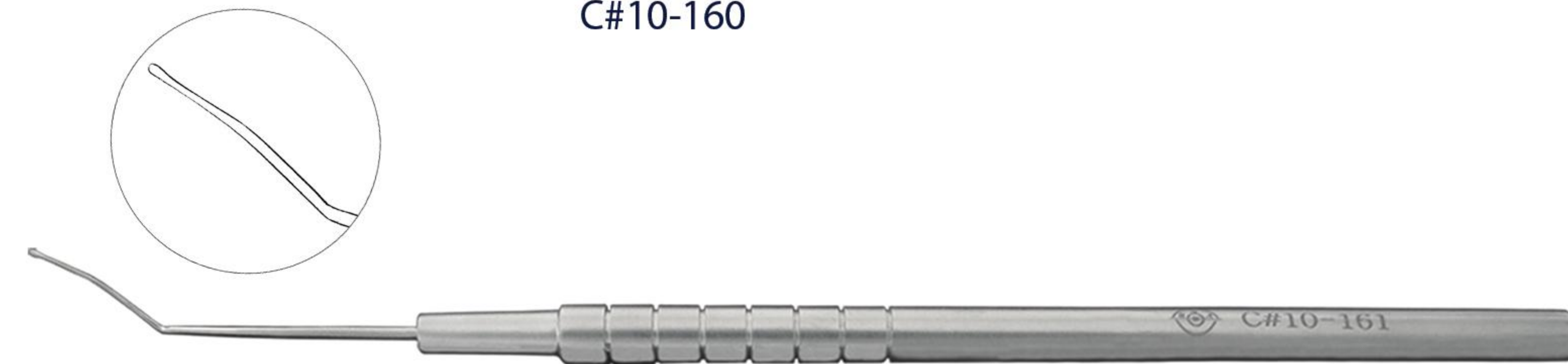

Phaco Spatula

Secondary Instrument  
Horizontal  
C#10-161

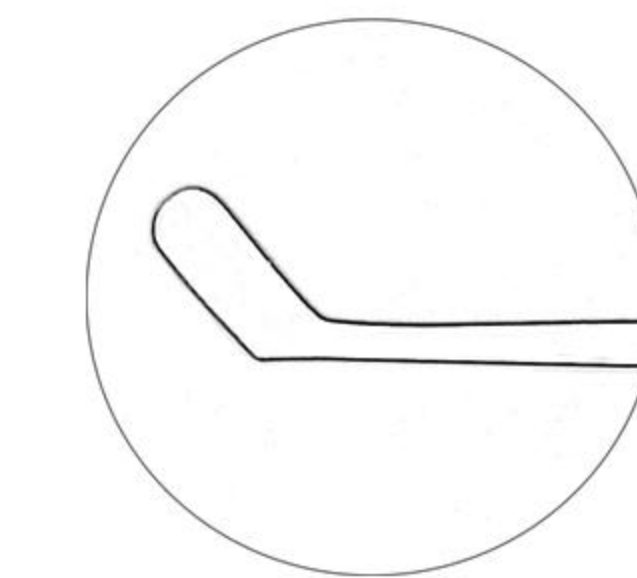

Epithelial- Detachment Spatula

Hockey Knife  
Lasek  
C#10-175-10

# BINA® INSTRUMENTS

## NEW PRODUCTS



Membrane Spatula  
F#10-450



Lazik Spatula  
B#50-300



## FIXATION RING



Spatula Hook



Spatula Hook



Epithelial- Detachment Spatula  
knife



Globe Fixation Ring  
Thornton  
C#10-166



Globe Fixation Ring  
Clear Cornea Incision  
C#10-165



Scleral Fixation Ring

Flieringa	
C#35-100/16	16 mm
C#35-100/17	17 mm
C#35-100/18	18 mm
C#35-100/19	19 mm
C#35-100/20	20 mm

## HOOK

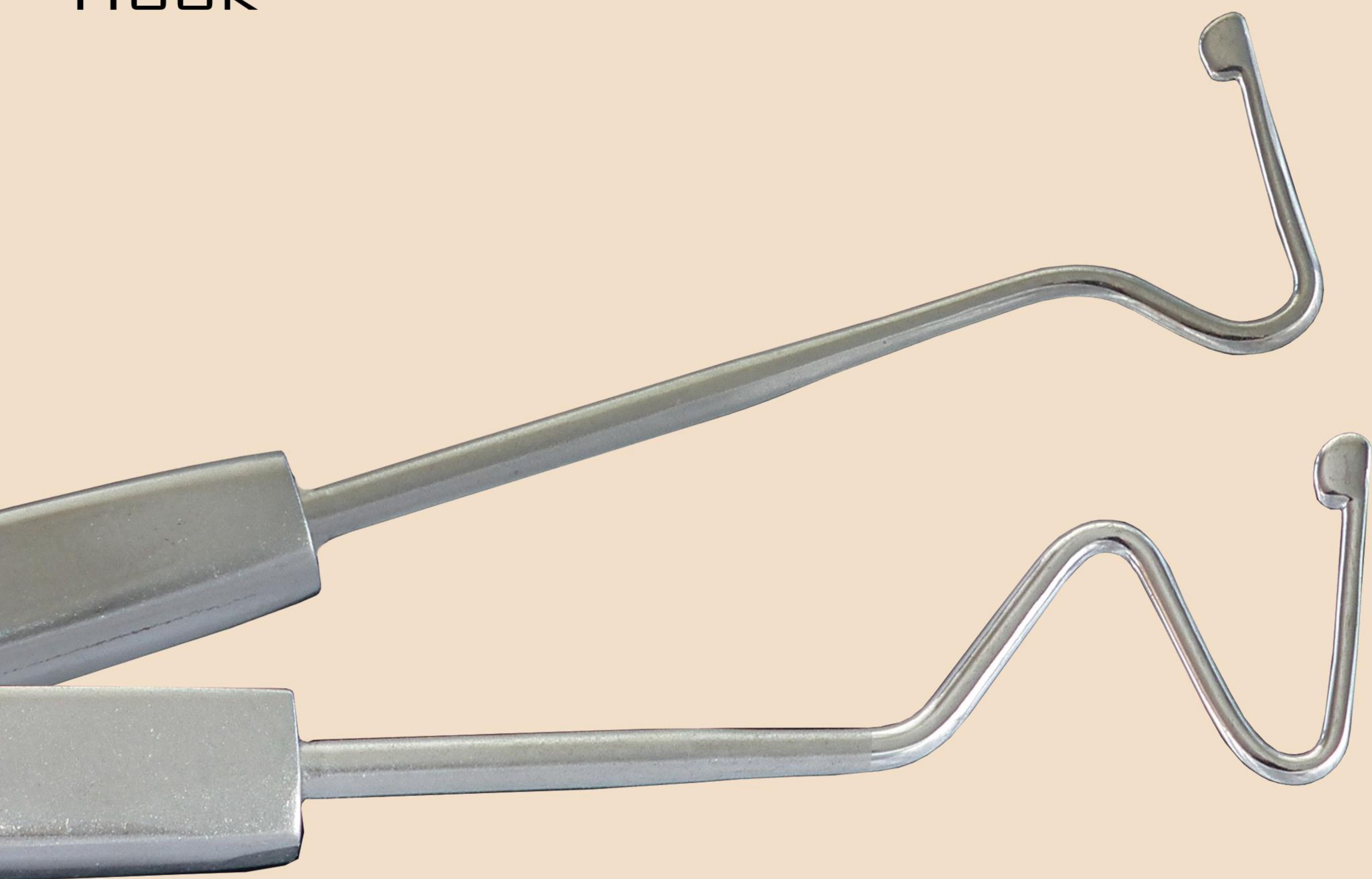

### Corneal Trephine For Lasek

C#10-170	7	mm
C#10-175	7.5	mm
C#10-180	8	mm
C#10-185	8.5	mm
C#10-190	9	mm
C#10-195	9.5	mm



### Alcoholic Solution Cone

#### For Lasek Procedure

C#10-180 A	8	mm
C#10-185 A	8.5	mm
C#10-190 A	9	mm
C#10-195 A	9.5	mm
C#10-100 A	10	mm
C#10-105 A	10.5	mm



Malbran Muscle Hook

Strabismus Hook  
C#20-450-30

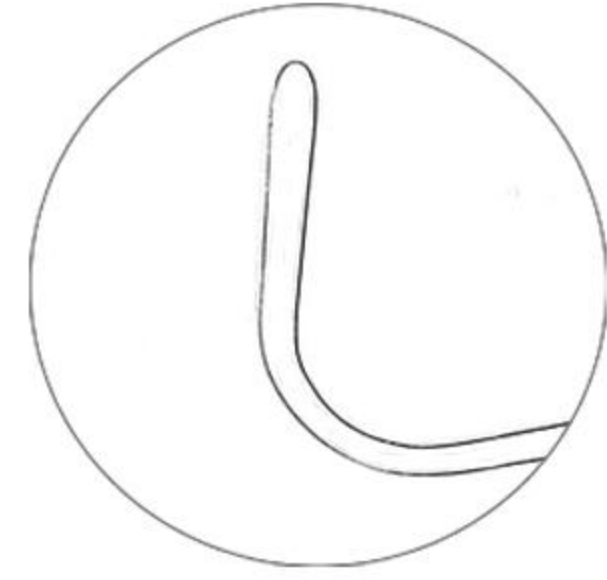

Graefe Muscle Hook

Strabismus Hook

C#20-451	Small	8.5 mm
C#20-452	Medium	10 mm
C#20-453	Large	11 mm



Guyton Muscle Hook

C#20-480



Jameson Muscle Hook

Strabismus Hook  
C#20-450

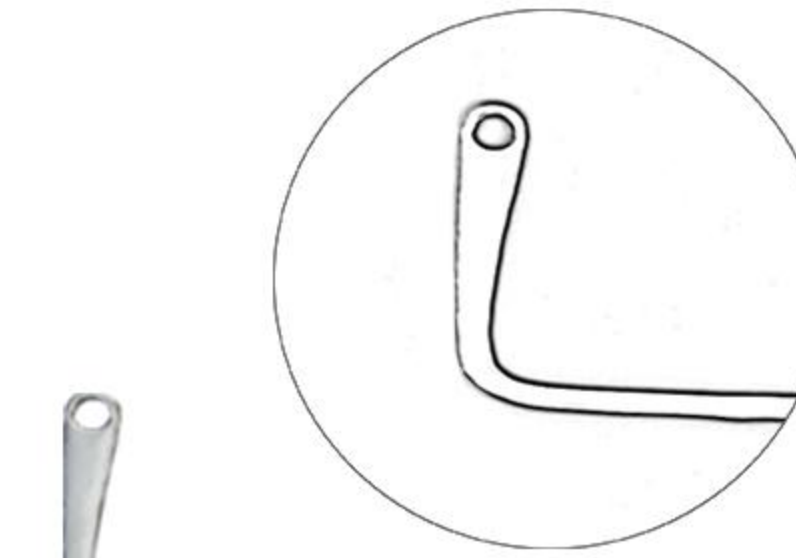

Retinal Detachment Hook

Flat Tip With Oval Hole  
C#20-450-10



Oblique Muscle Hook

Strabismus Hook  
C#20-450-20

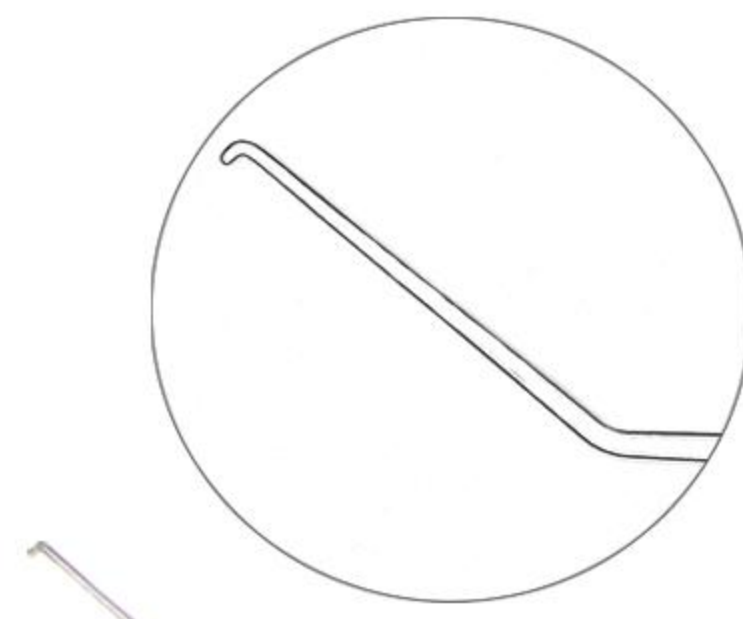

Sinskey  
IOL Manipulating Hook  
0.25 mm dia, Blunt tip, Angled  
C#10-120



H o o k

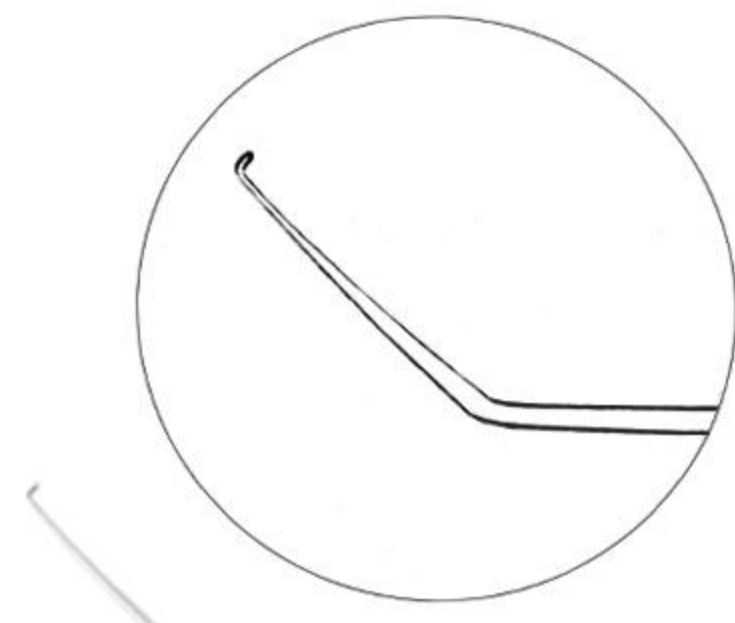

Reversed Sinskey Manipulator  
For Scoring the perimeter of the recipient endothelium  
and for manipulation of the donor Lamella  
C#10-120-R

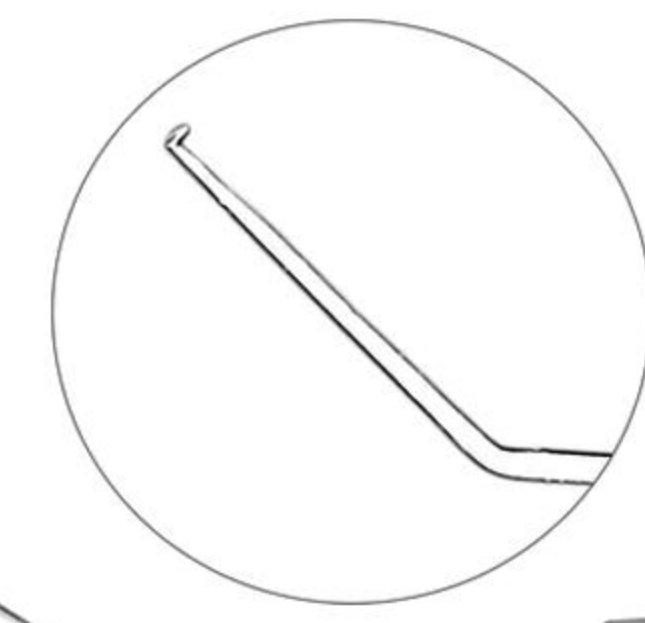

Stripper  
For Stripping And Removing  
The Endothelial Layer  
C#10-175-30

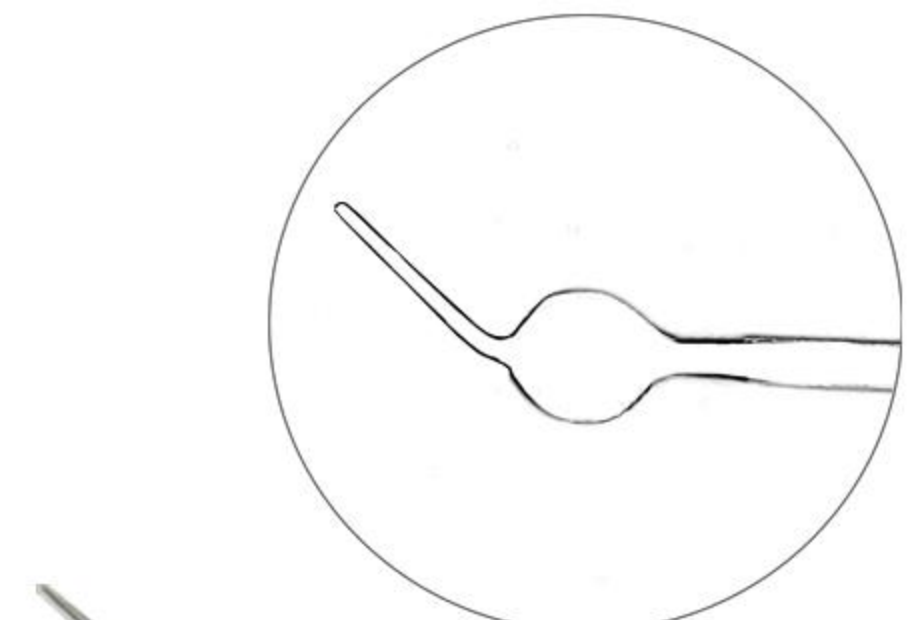

Eye Cautery  
C#10-300

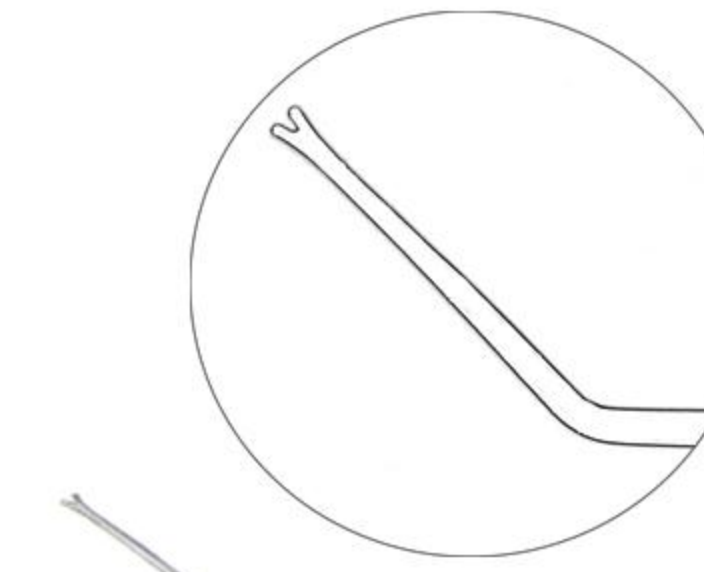

"Y" Hook Lens Manipulator  
For Lenses Without Holes  
C#10-140



H o o k

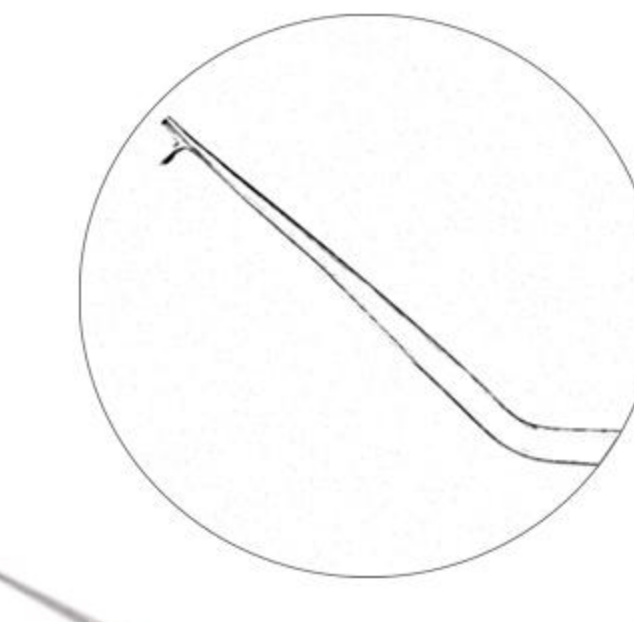

"T" Hook Lens Manipulator  
For Lenses Without Holes  
C#10-110

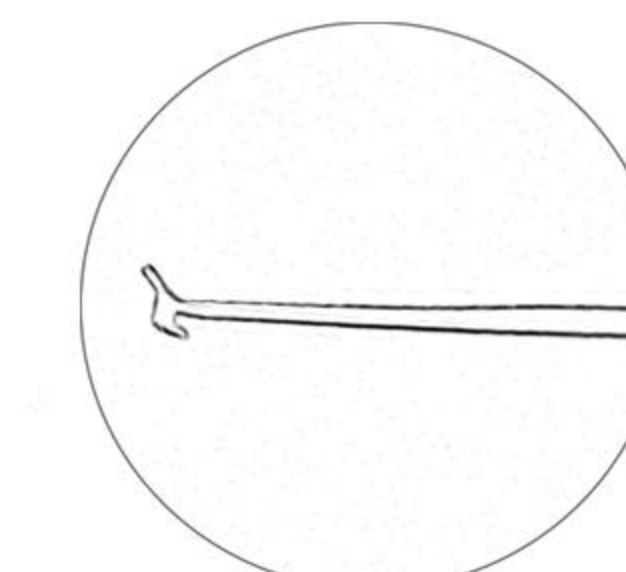

Artisan Lens Hook  
Lens Manipulating Hook  
& Iris Retractor  
C#10-145



## RETRACTOR

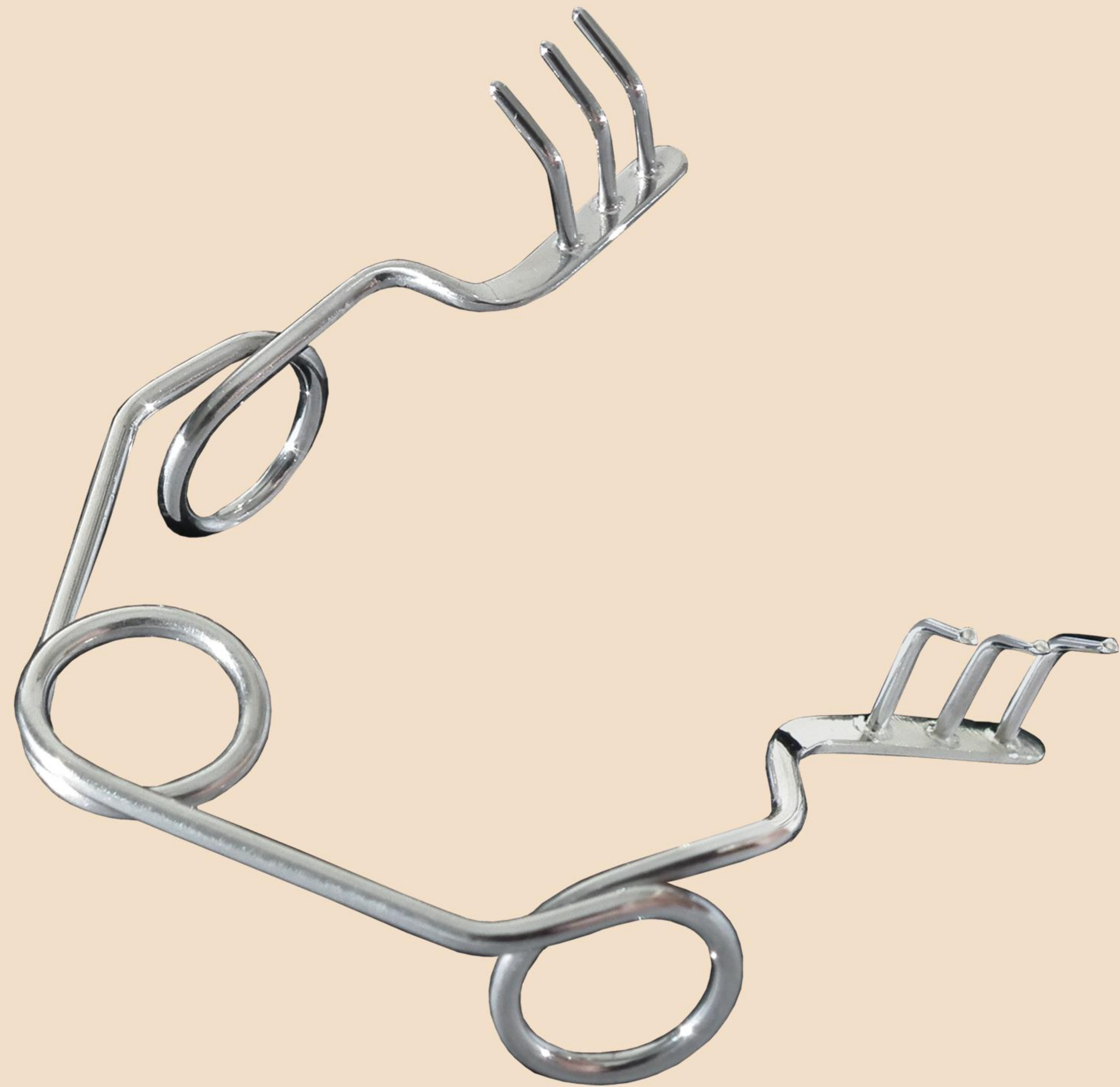

Pigtail Hook  
B#40-480

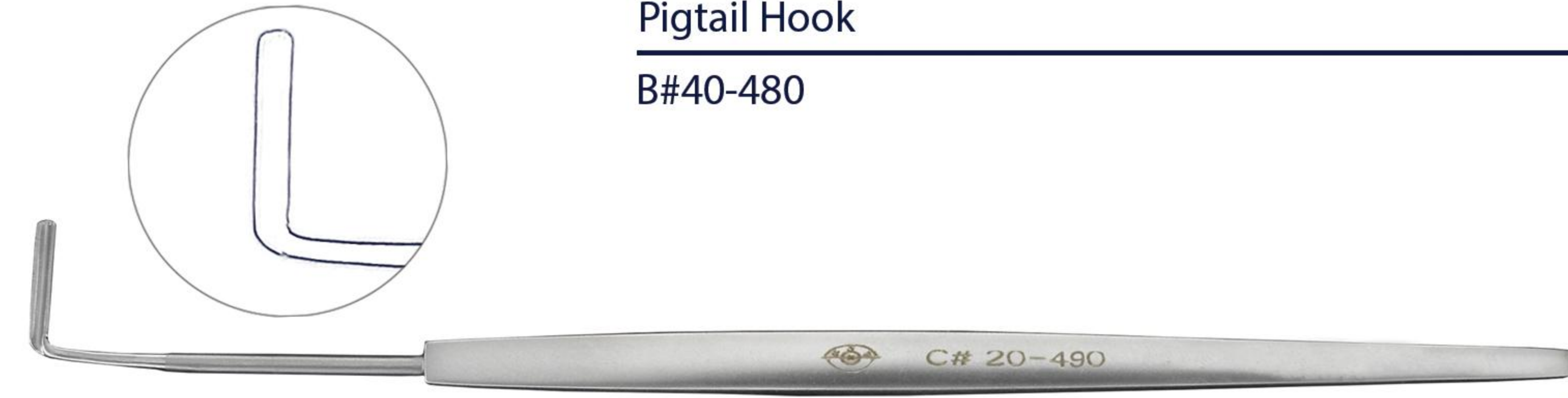

Wright Type Grooved Hook  
C#20-490



Kuglen  
Lens Manipulator and Iris Hook  
C#10-130



Micro Iris Hook  
Very Delicate  
C#10-135



Jaeger Lid Plate  
B#40-545



Lachrymal Sac Retractor  
DCR  
B#40-130



Iris Retractor  
6.2 mm  
C#10-135A



Desmarres  
Lid Retractor  
With Solid Blade  
F#10-411 14 mm  
F#10-412 12 mm  
F#10-413 10 mm



Orbital Spatula  
University Of BONN Model  
F#10-400 Large 11 mm  
F#10-405 Small 9 mm



Lachrymal Retractor  
B#40-150  
With 4 Prongs

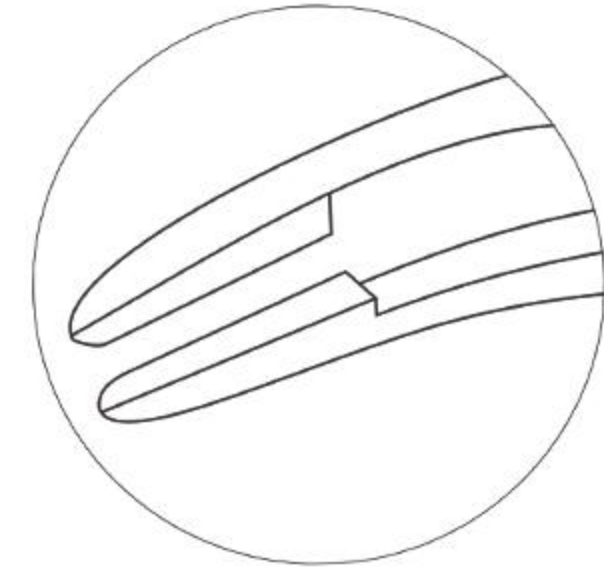

Tying Forceps 10-0  
Curved, With Micro Platforms  
10 cm Long  
B#13168

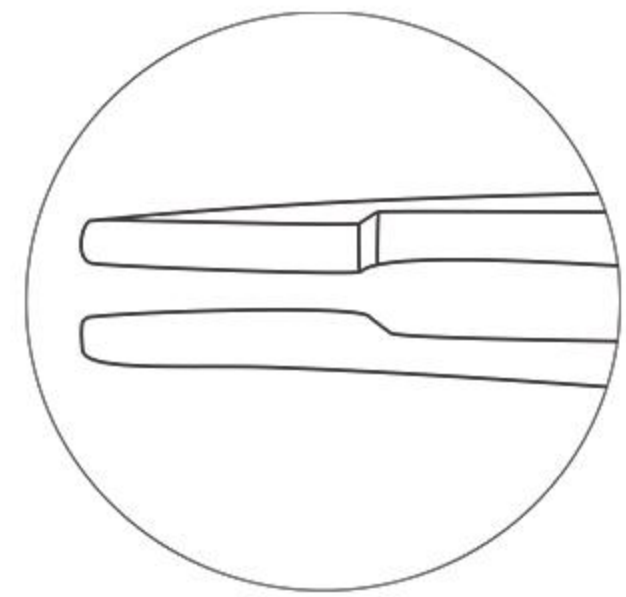

Tying Forceps 10-0  
Straight, With Micro Platforms  
10 cm Long  
B#7850 C

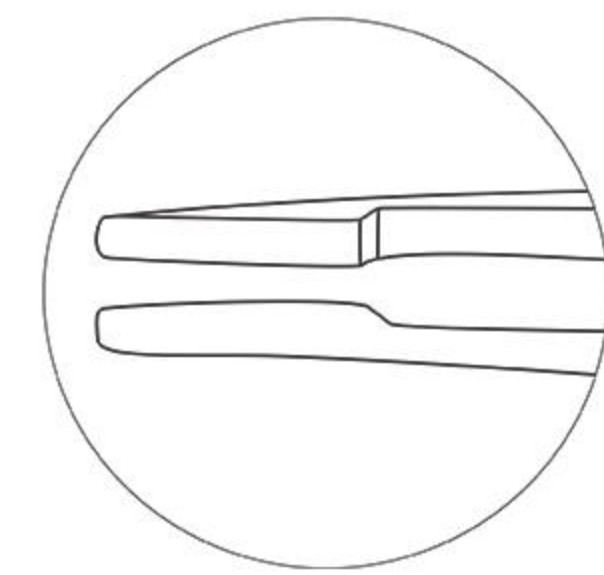

Tying Forceps 8-0  
Straight, With Micro Platforms  
B#2432

## FORCEPS

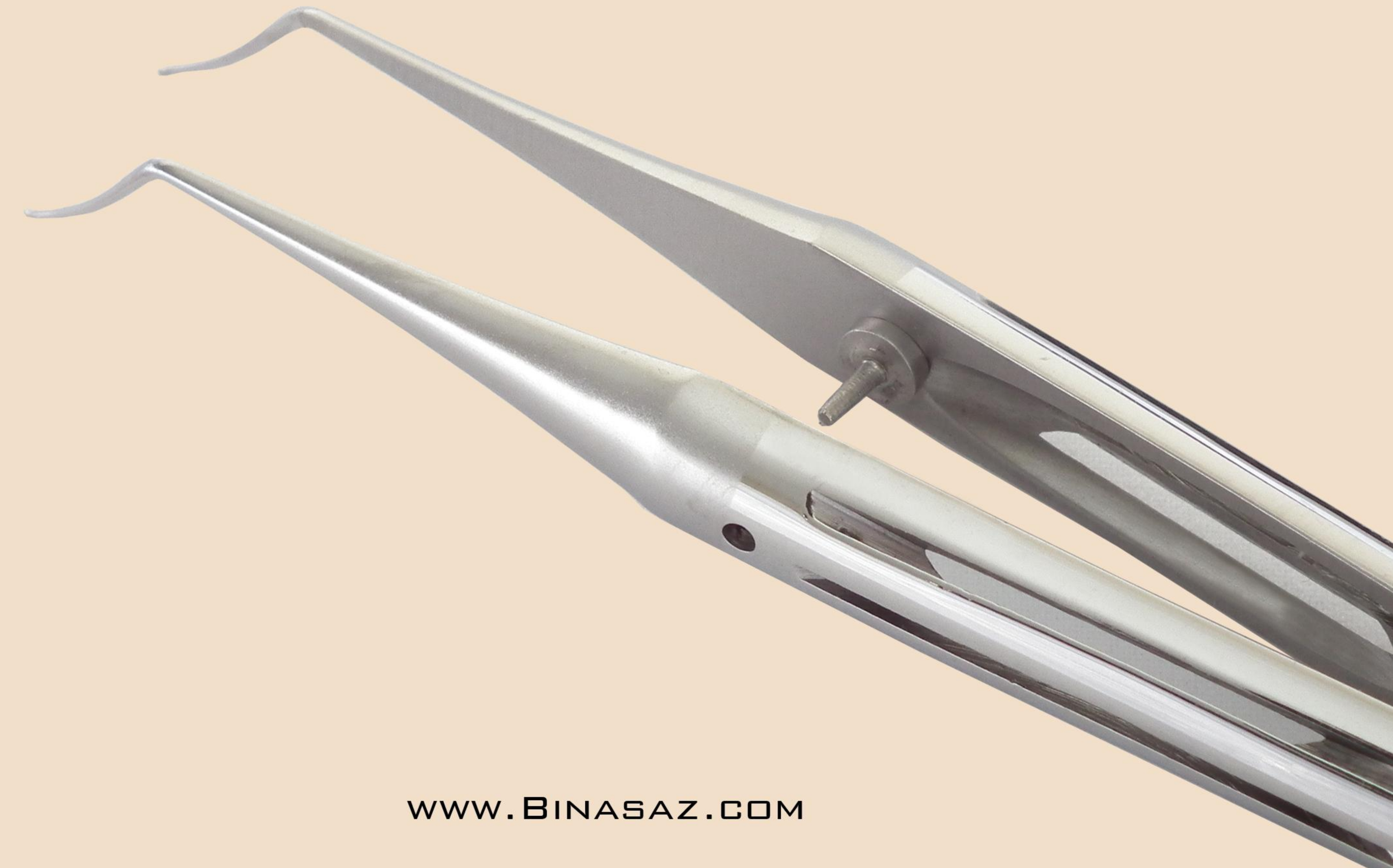

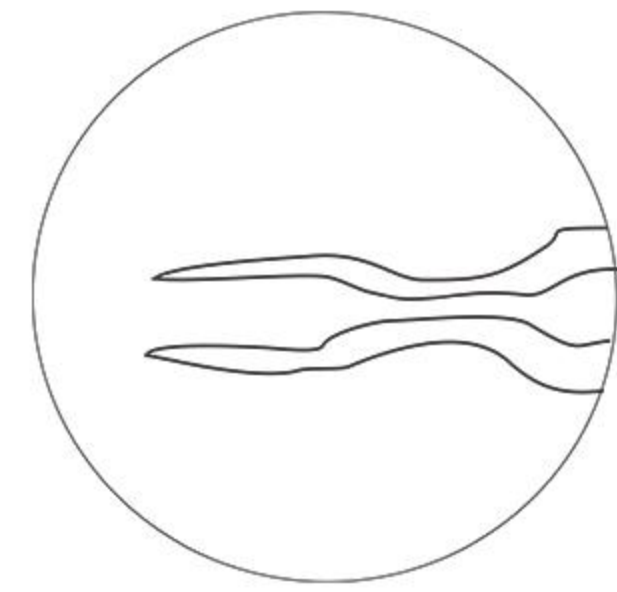

**Akahoshi Phaco PreChopper**

For Cracking, Dividing and Rotating  
The Nucleus Without Sculpting

B#AS-130 Straight  
B#AS-140 Curved

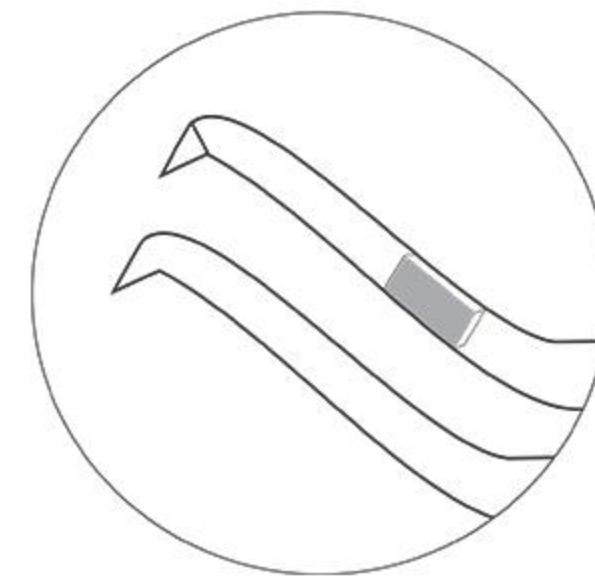

**Capsulorhexis Forceps**

Ergonomic, Curved  
Cystotome Tips  
11.5 cm long  
B#18259

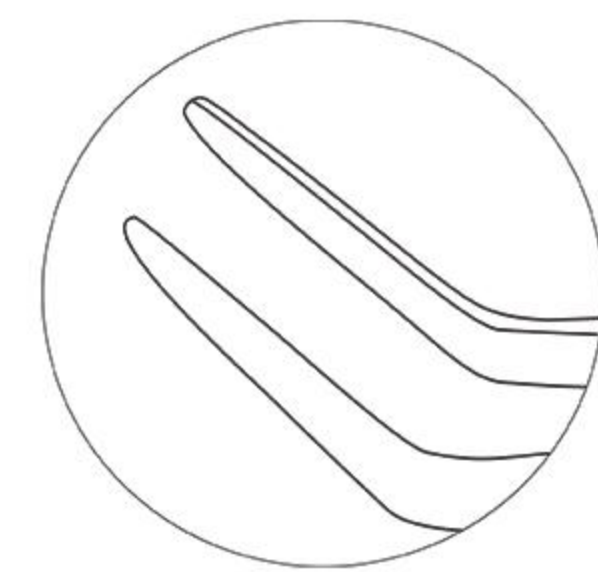

**McPherson Forceps**

Long Smooth Jaw  
Delicate  
Platform 11 mm  
B#17161

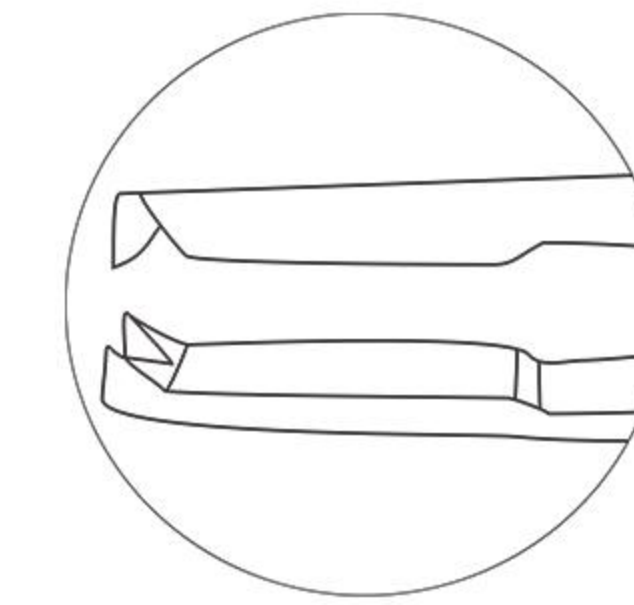

**Castroviejo Forceps**

Oblique Teeth 0.4 mm  
With Tying Platform  
B#7348

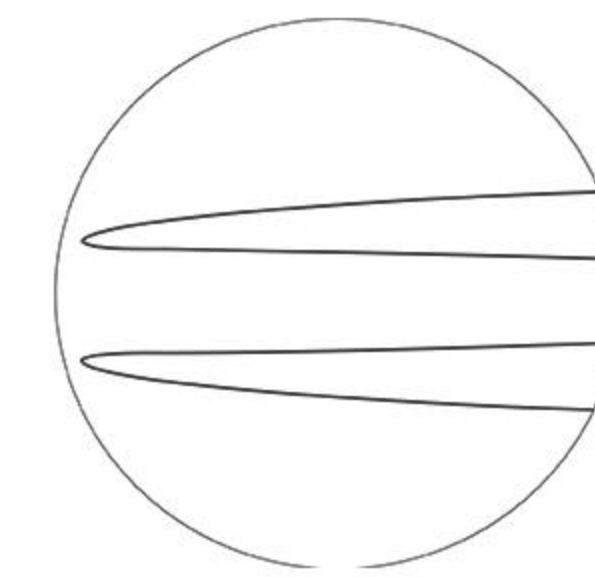

**Jewelers Forceps**

B#3050

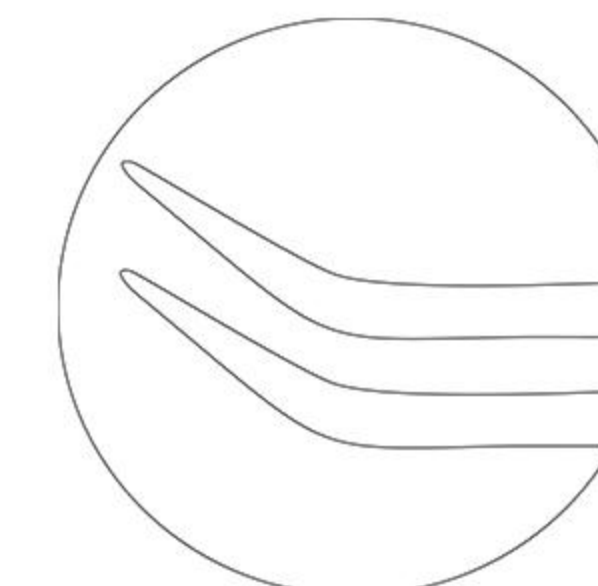

**Jewelers Forceps**

Angled  
B#3060

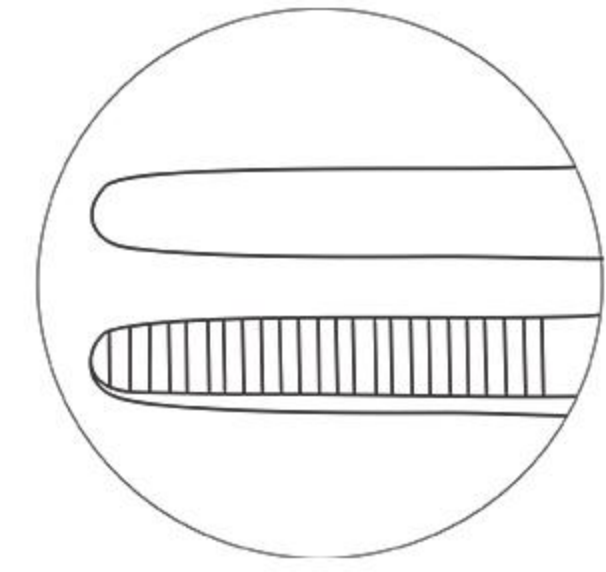

Dressing Forceps  
Serrated, Delicate  
Straight  
B#2180A

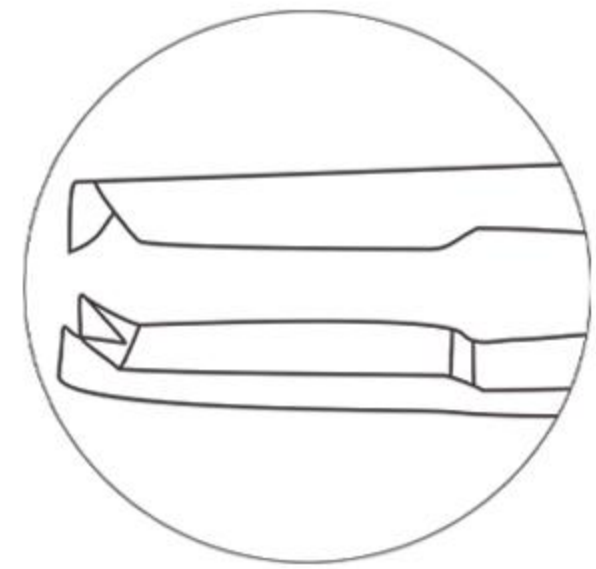

Fixation Forceps 1\*2 teeth  
1\*2 teeth, 0.3mm  
With Tying Platforms  
B#3225

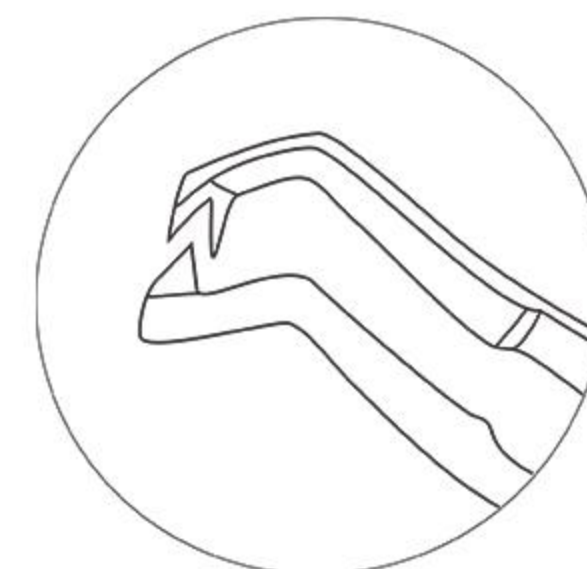

Barraquer- Troutman Forceps  
Colibri Type, Oblique Teeth 0.12 mm  
With Tying Platforms  
B#7862

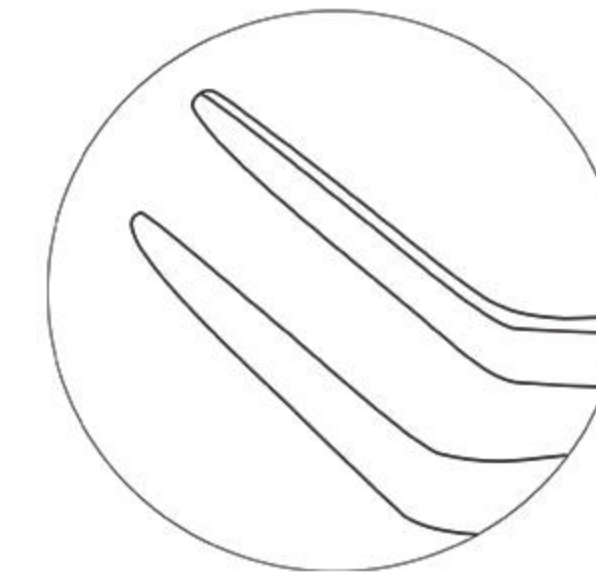

McPherson Forceps  
Ergonomic, Angled  
Platform 11 mm  
B#13242

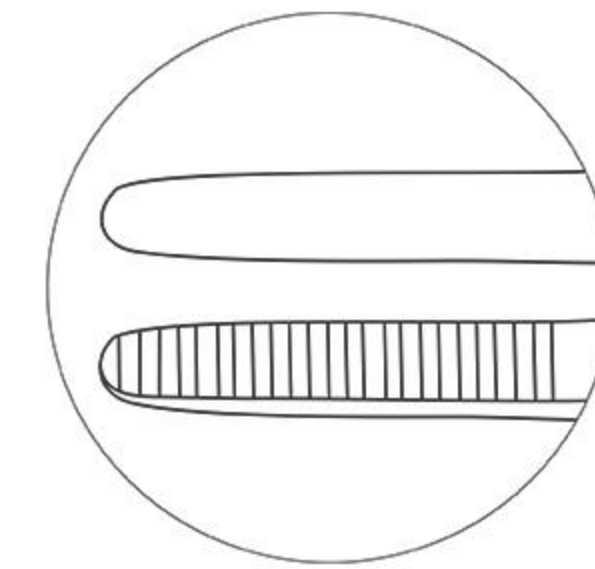

Bayonet  
Dressing Forceps  
Serrated Jaws  
B#9035

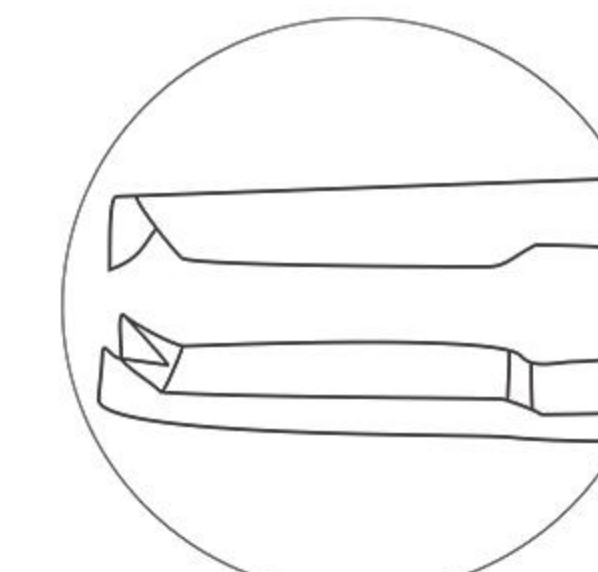

Castroviejo Forceps  
Oblique Teeth 0.12 mm  
With Tying Platform  
B#3045



Chalazion Forceps

B#2131 Medium 13 mm  
B#2042 Small 11 mm



Chalazion Forceps

B#2125 Medium 25 mm  
B#2044 Small 20 mm



Artisan Lens Implantation Forceps

B#13240



Lens Holding Forceps

Curved  
B#13238





Mosquito Forceps Curve  
B#18181



Mosquito Forceps  
B#18180



Foerster Sponge Forceps  
B#18200



Towel Clamp  
B#18160

F o r c e p s

پیش و بست



Entropion Forceps

B#8401	Small	Left	20 mm	B#8400	Small	Right	20 mm
B#8211	Medium	Left	25 mm	B#8210	Medium	Right	25 mm
B#8441	Large	Left	30 mm	B#8440	Large	Right	30 mm



Chalazion Curette

B#40-451	Small
B#40-452	Medium
B#40-453	Large

F o r c e p s

پیش و بست



Castroviejo Needle Holder 8-0  
Delicate, Straight Jaws, Without Lock  
Gentle Spring Action  
B#8148



Barraquer - De Laage Needle Holder 10-0  
Curved Jaws 1 mm, Without Lock  
13 cm Long  
B#7251

# BINA® INSTRUMENTS

## NEEDLE HOLDER

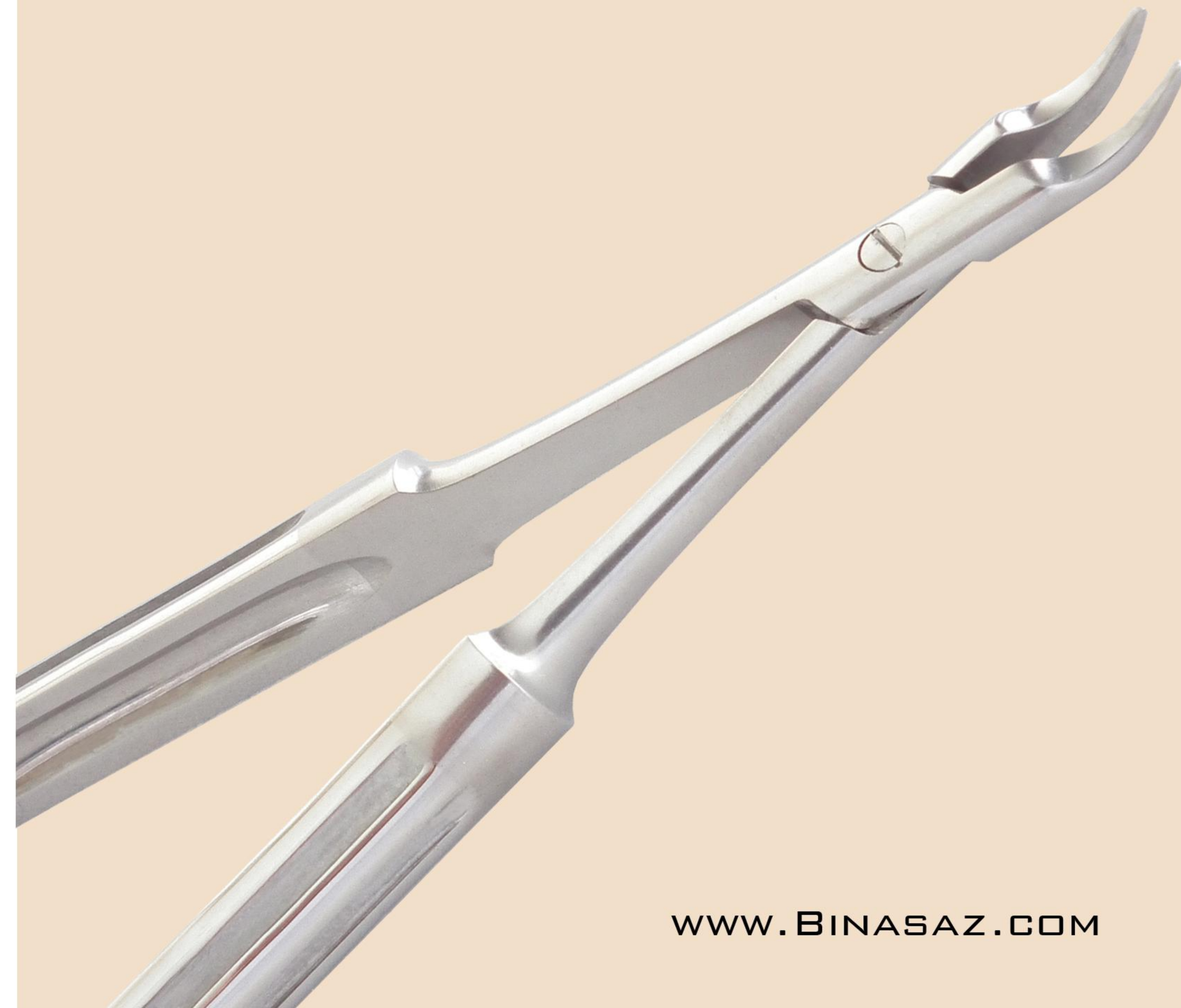

Scissors

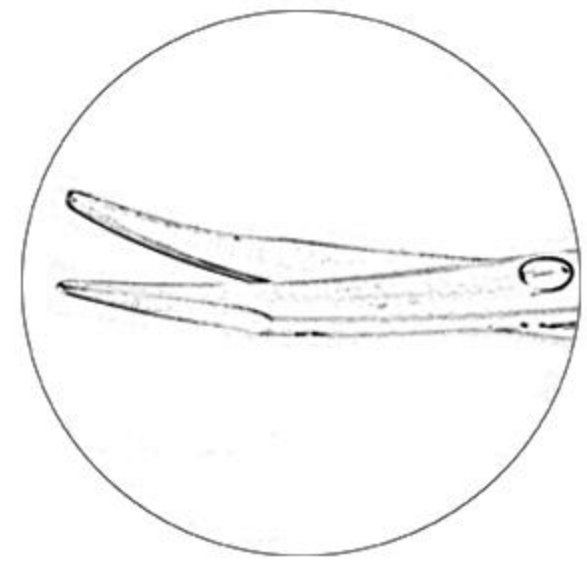

Stevens Tenotomy Scissors Standard

Blunt  
B#4251A

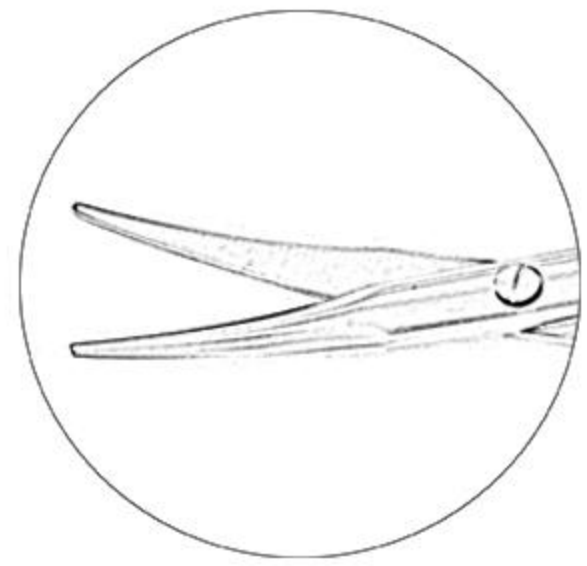

Stevens Tenotomy Scissors

Blunt  
B#18013

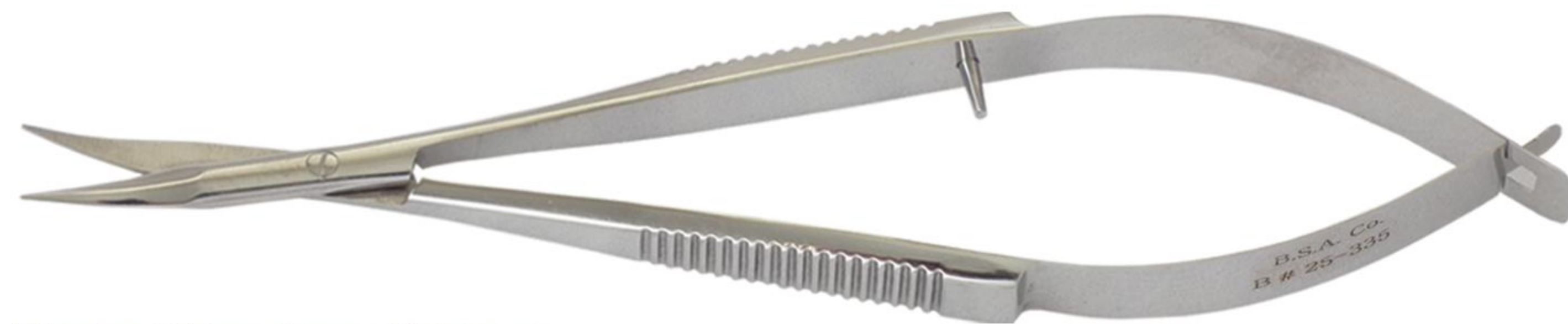
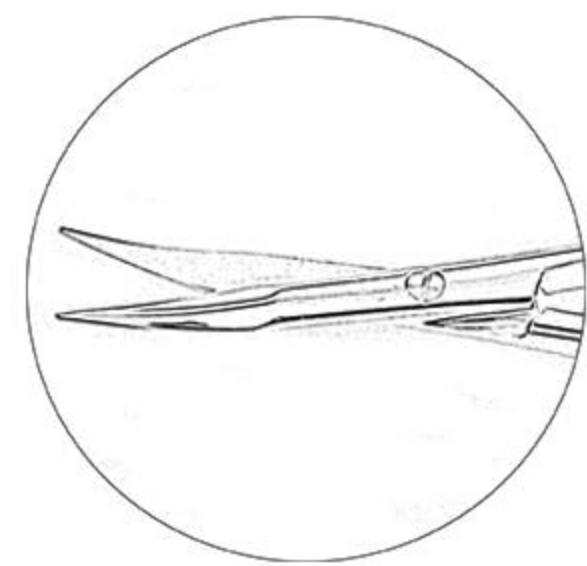

Westcott Tenotomy Scissors

Standard  
B#25-335

# INSTRUMENTS

## SCISSORS

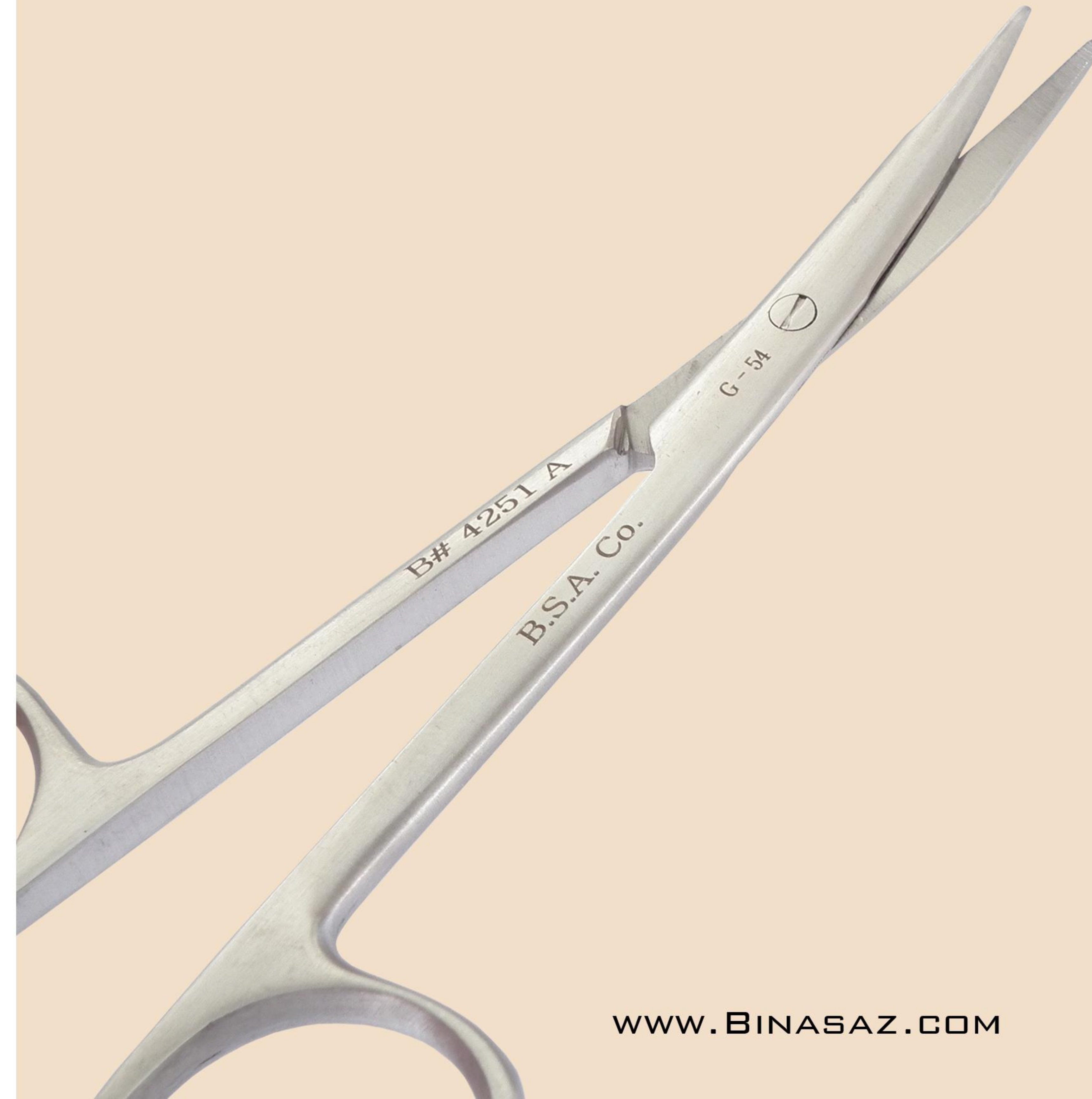



**Vannas Scissors**  
Straight Pointed, Blades 5 mm × 0.5 mm  
B#9600  
Curve Pointed, Blades 5 mm × 0.5 mm  
B#9601



**Castroviejo Corneal Section Scissors**  
B#80-23A Counter Clockwise  
B#80-23B Clockwise



**Westcott Scissors**  
B#1427



**Corneal Scissors**  
Curved  
B#8100



**Castroviejo Eye Scissors**  
B#9721

## LID SPECULUM

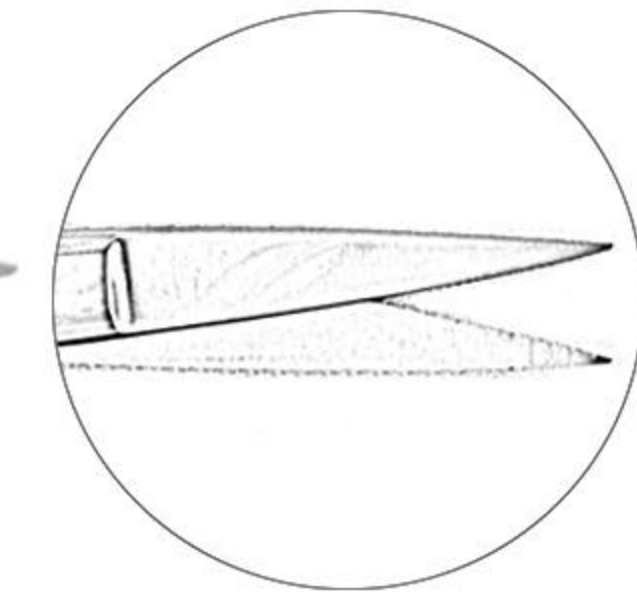
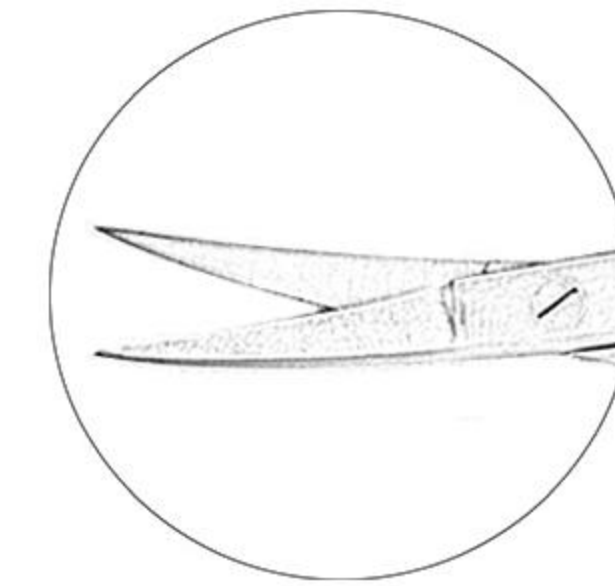

### Eye Scissors

Straight Blade With Pointed Tips

B#4877

Curve Blade With Pointed Tips

B#4878



L i d S p e c u l u m

پلک بازکن

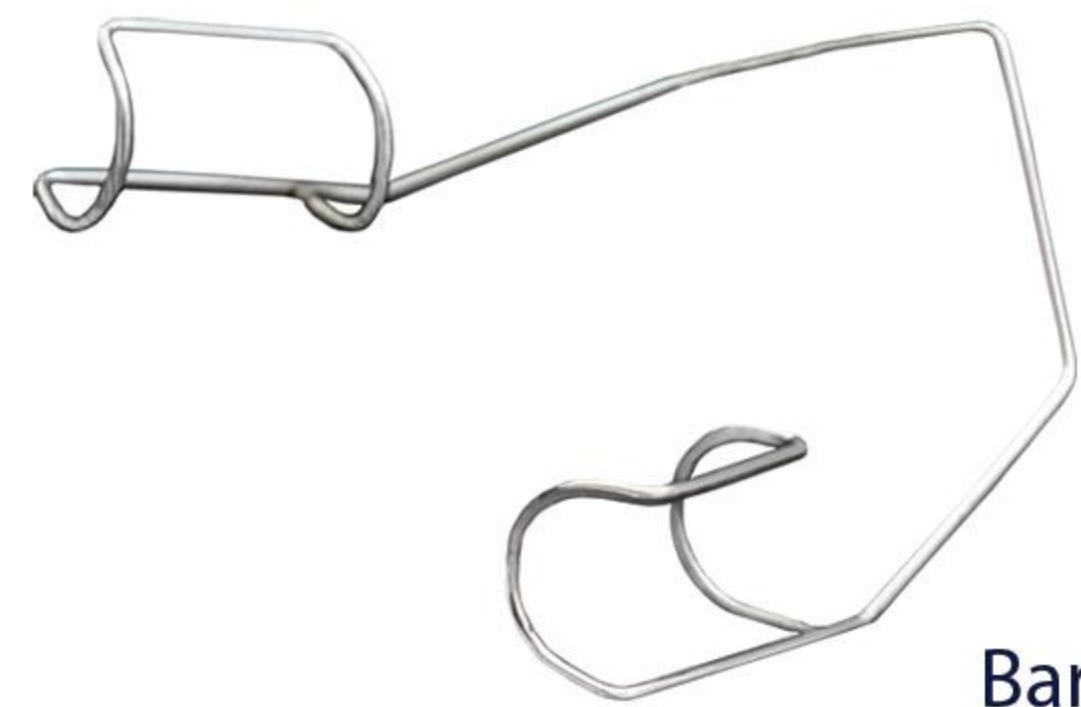

Barraquer Wire Speculum  
Fenestrated  
B#60-104 L 14 mm Adult  
B#60-104 M 10 mm Child  
B#60-104 S 5 mm Infant



Barraquer Wire Speculum  
Fenestrated, Open Blades  
B#60-103 5mm Infant  
B#60-103 P 3mm Premature



Liberman Speculum  
Solid Blades  
B#60-320 13.5 mm Adult  
B#60-320 S 5 mm Infant



Liberman Open Wire Blades  
B#60-300 15 mm Adult  
B#60-300 S 10 mm Child

L i d S p e c u l u m

پلک بازکن



Barraquer Wire Speculum  
B#60-105 L 14 mm Adult  
B#60-105 M 10 mm Child  
B#60-105 S 5 mm Infant



Barraquer Wire Speculum Fenestrated  
B#60-100 L 14 mm Adult B#60-100 S 5 mm Infant  
B#60-100 M 10 mm Child B#60-100 P 3 mm Premature

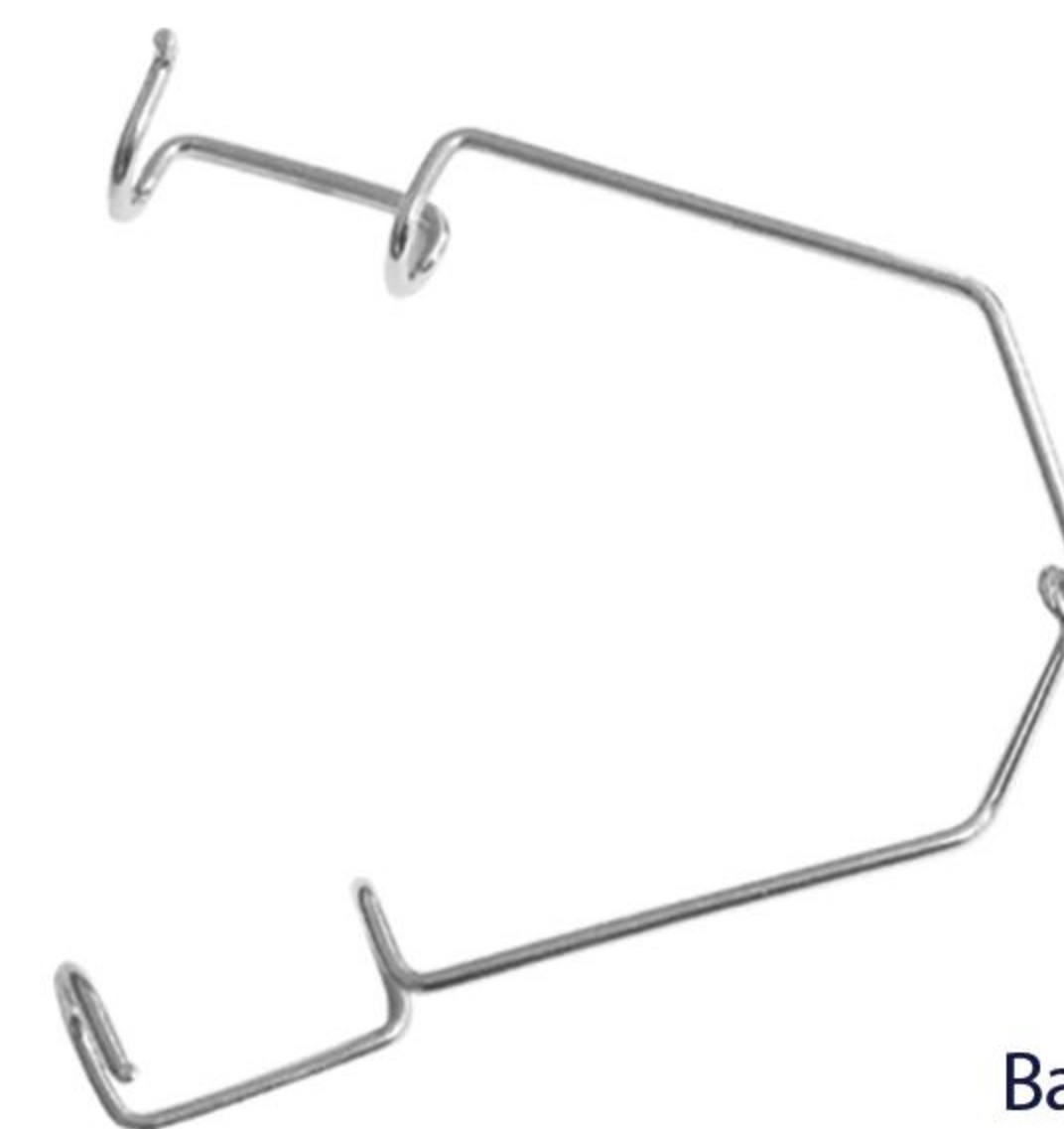

Barraquer Wire Speculum  
Fenestrated, Open Blades  
B#60-101



Barraquer Wire Speculum  
Fenestrated, Open Blades  
B#60-102

## LACHRYMAL



Eye Speculum  
Solid Blades  
B#60-100-P



Reversible Speculum  
Solid Blades  
B#60-340 13.5 mm



Alfonso, Wire  
Infant Child Speculum  
Fenestrated Interlacing  
5 and 8 mm Blades  
B#60-106



Sauer Speculum  
B#60-50-S 8 mm Blades



Sauer Speculum  
B#60-50 8 mm Blades



Crawford Retrieving Hook

- B#40-600 With Round Handle
- B#40-605 With Square Handle



Trabeculotomy Probe  
B#40-460



Bowman Lachrymal Probe

Cylindrical Tip, Malleable S.Steel

- B#40-230 1/2
- B#40-330 0/00
- B#40-430 000/0000



Lachrymal Dilator  
B#40-500



Aspirating Hand Piece  
Manual Control  
Without Silicone Chamber  
F#10-180  
Cannula Size: G.20, G.23



BackFlush Hand Piece  
With Silicone Chamber  
F#10-100  
Cannula Size: G.20, G.23

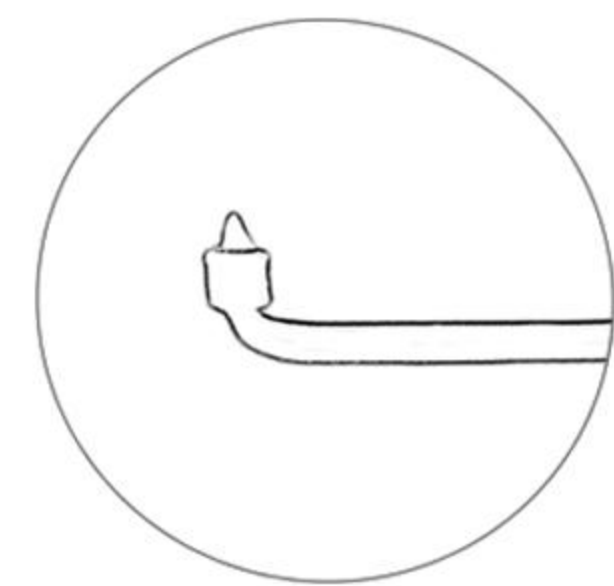

Localizer  
F#10-300

# BINA® INSTRUMENTS

## RETINAL

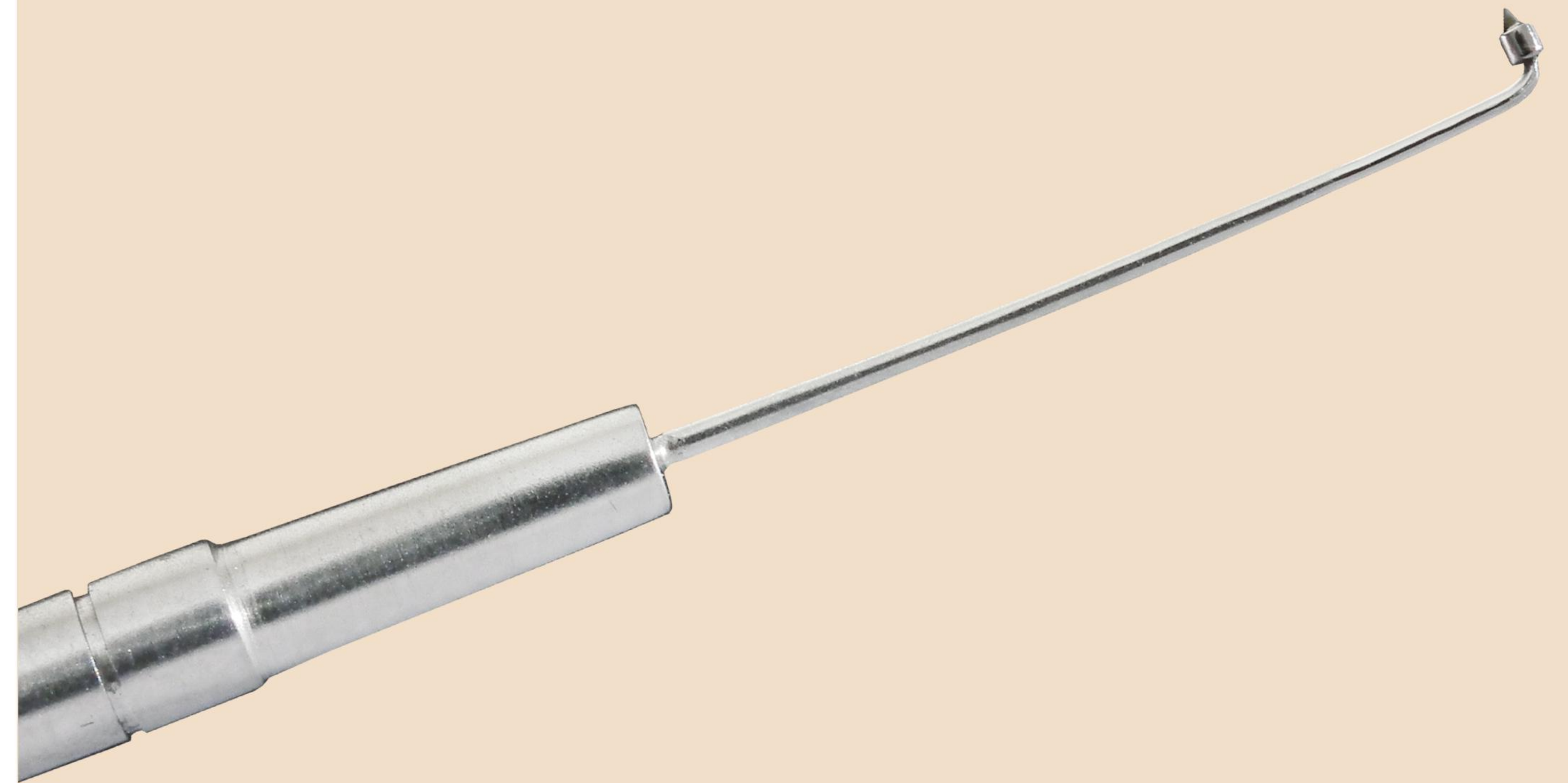

## CHOPPER

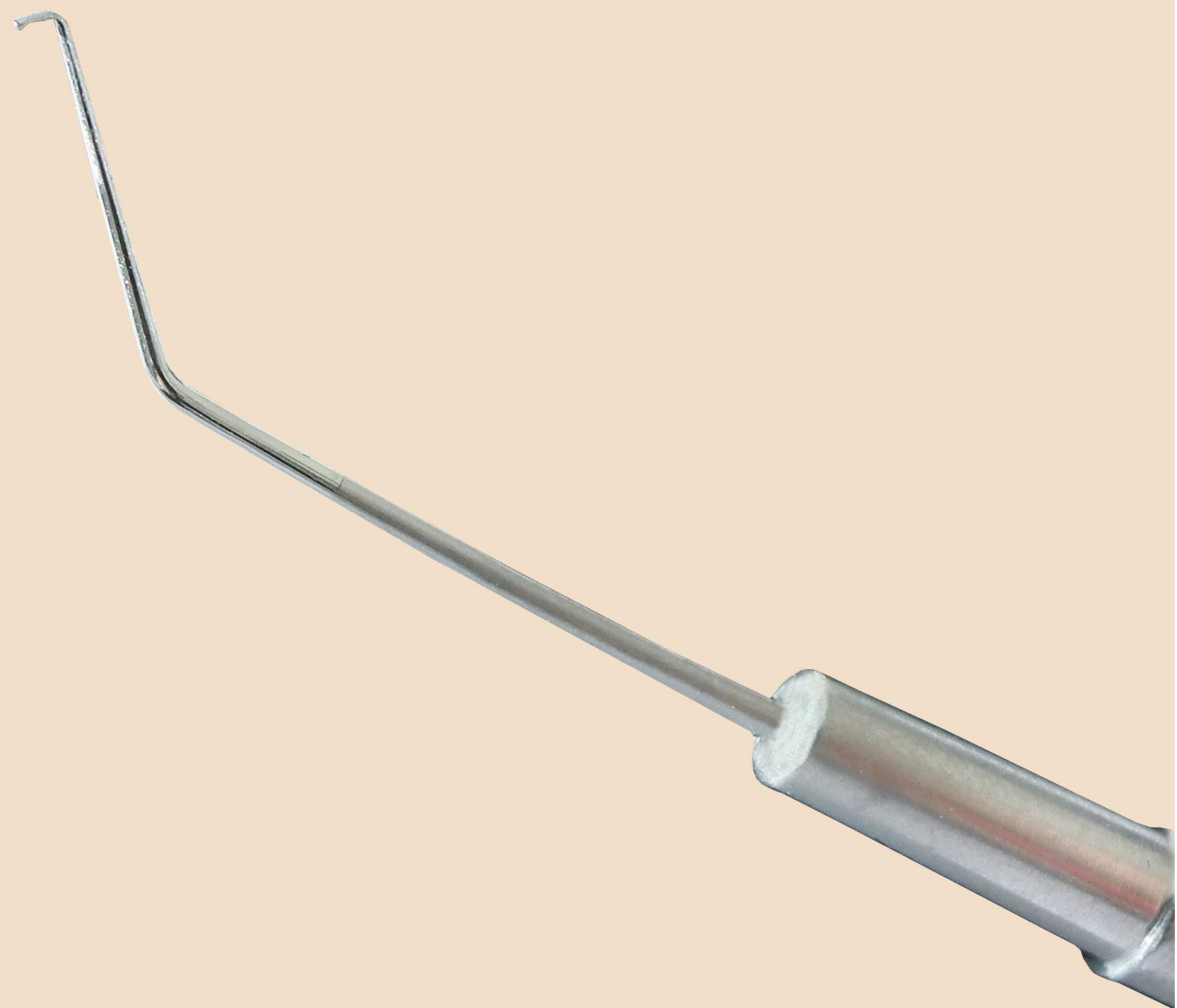

Scleral Depressor

- F#10-350 Large
- F#10-360 Small

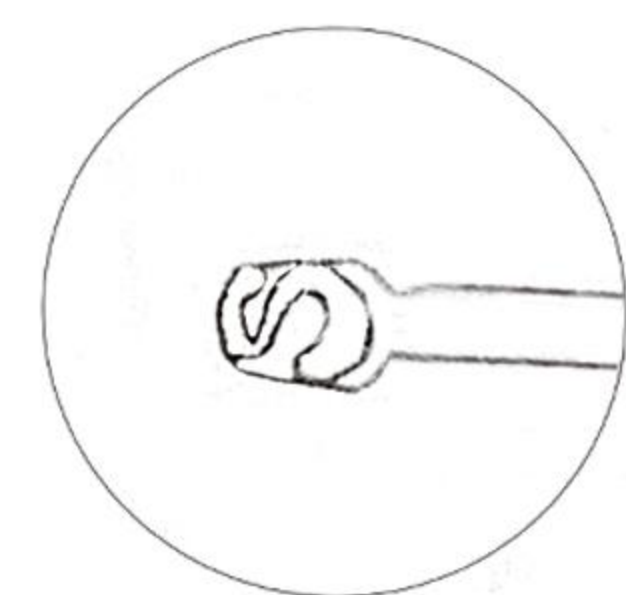

Lamellar Keratoplasty "S" Marker

C#10-400



Lens Holding Ring  
With Silicone Tube  
For Suturing To Scleral  
B#30-100A

Lens Handle Ring  
With Silicone Tube  
For Suturing To Scleral  
B#30-100



Chung Phaco Chopper  
C# 20-270



Phaco Chopper  
Nagahara-Type  
Irrigating-Cannulated  
C#20-201



Minardi Phaco Chopper  
C#20-255  
C#20-255 T (Titanium)



90° Phaco Chopper  
C#20-200  
C#20-200 T (Titanium)



45° Phaco Chopper  
C#20-250  
C#20-250 T (Titanium)



Nucleus Divider  
Phaco Section  
C#10-250



45° Phaco Chopper  
C#20-250  
C#20-250 T (Titanium)



Mendez  
Degree Gauge  
C#35-200



Marking Caliper  
B#8232F 4 mm, 3.5 mm



Marking Caliper  
B#8232 20 mm



Keratoscope- Aluminium  
C#35-255



Keratoscope- Stainless Steel  
C#35-250

# BINA® INSTRUMENTS

## MEASURING

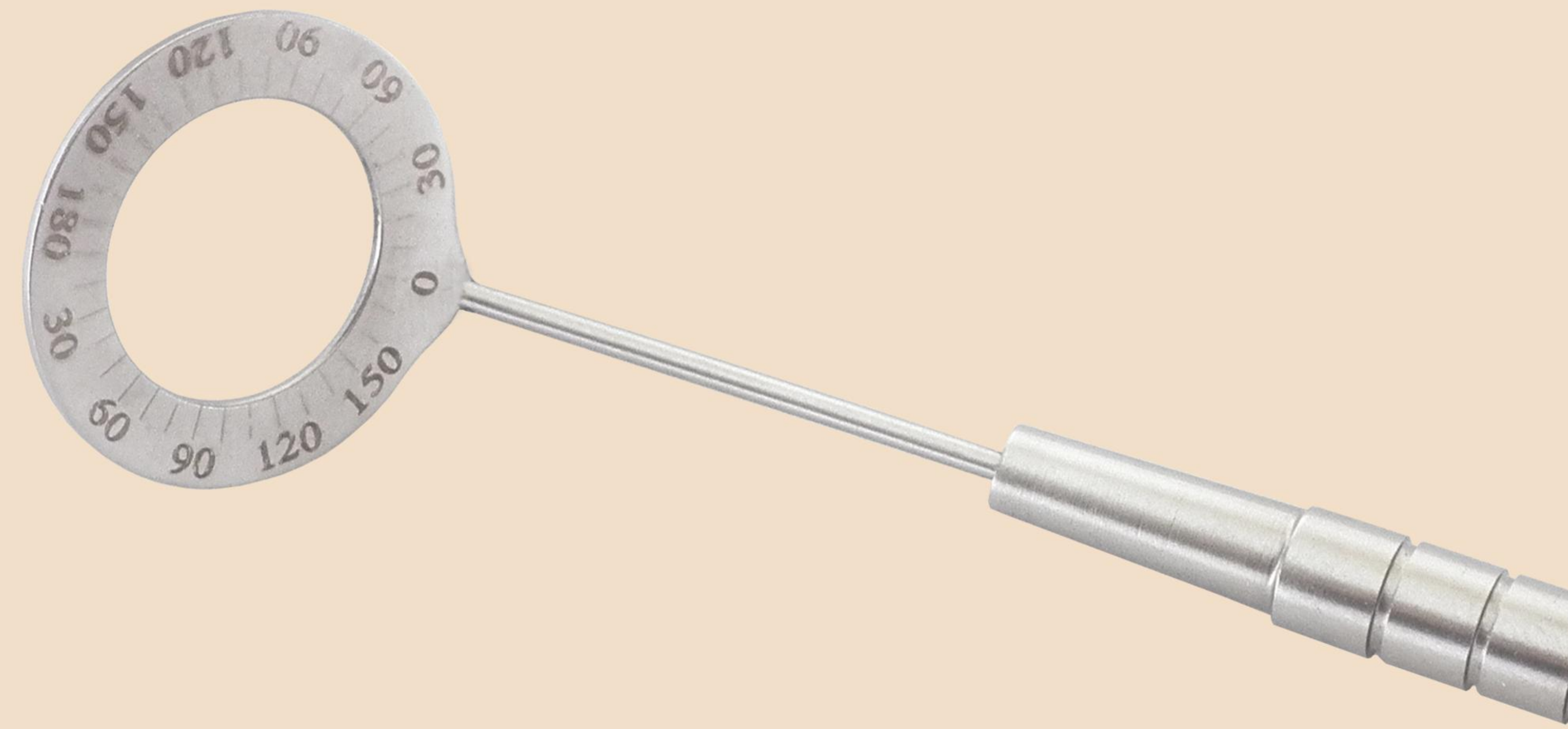



De Wecker Forceps  
Curved  
Serrated Jaws  
B#MC 44



De Wecker Forceps  
Straight  
Serrated Jaws  
B#MC 43



Lens Loop  
C#10-350 Large  
C#10-351 Small



Cottle Nasal Speculum  
B#9004

# BINA<sup>®</sup> INSTRUMENTS

## GENERAL

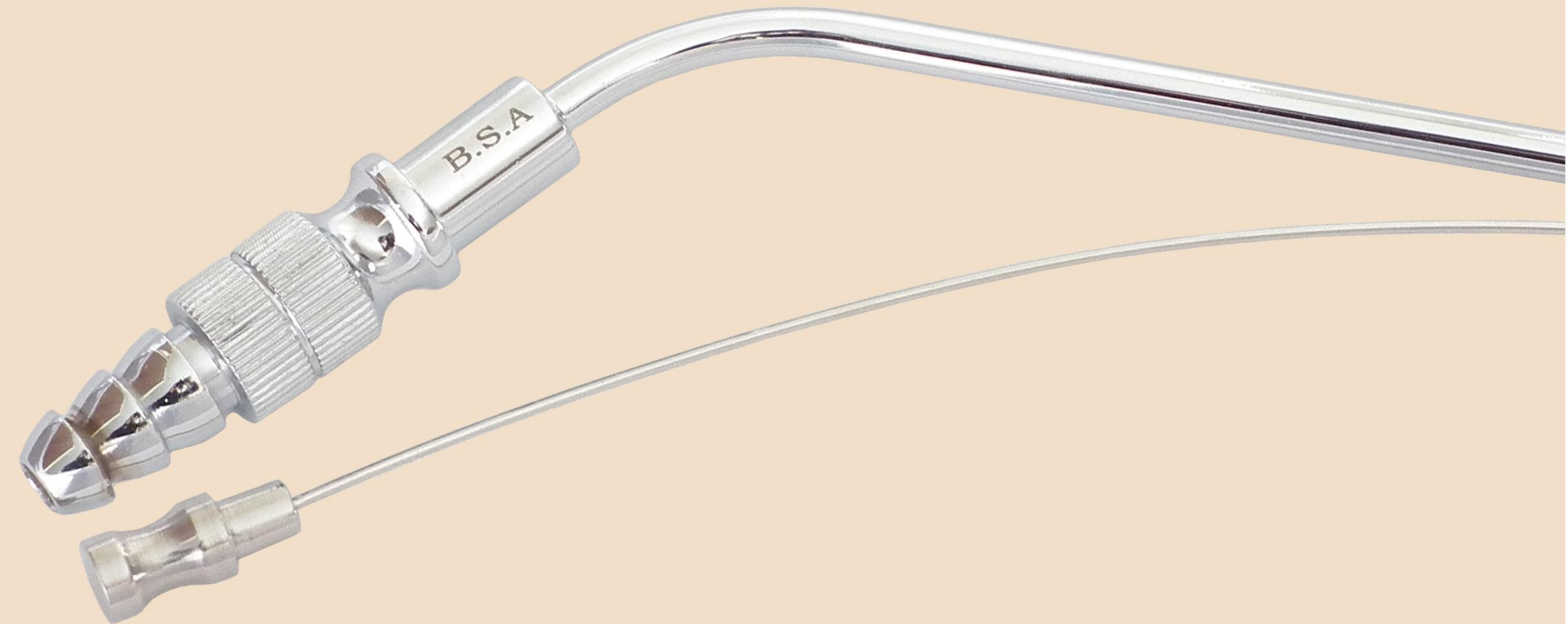



Osteotome groove  
B#40-750 4 mm



Osteotome  
B#40-770 4 mm



Mallet  
B#40-700 150 gr



Double Ended Periosteal Elevator  
B#790-40



Suction Tube  
FR 12  
B#80-80 8 cm  
B#80-100 10 cm  
B#80-110 11 cm  
B#80-120 12 cm



Ilif Wright Fascia Needle  
Eye Overall Length  
Eye Overall Length  
B#40-510 Large 140 mm  
B#40-510-S Small 120 mm



Phaco Tip Wrench  
Storz Type  
B#80



Phaco Tip Wrench  
Alcon Type  
B#80-1 Stainless Steel B#85 Single Use



Scalpel Handle  
B#5500



Silicone Tube



Stainless Steel Eye Shield

Handle	Large	B#40-525 H - L	34 mm×23 mm
	Medium	B#40-525 H - M	32 mm×21 mm
	Small	B#40-525 H - S	30 mm×19 mm
Normal	Large	B#40-525 L	34 mm×23 mm
	Medium	B#40-525 M	32 mm×21 mm
	Small	B#40-525 S	30 mm×19 mm



D.C.R  
Rongeur  
3mm  
90°  
B#1380

Refractive Set

Irrigating Cannula Curved For Lasik  
B#50-220  
B#50-220/2 p.5



Liberman Lid Speculum (K-wire)  
B#60-300 p.48



Degree Gauge Mendez  
C#35-200 p.60



Lazik Spatula  
B#50-300 p.13



Corneal Trephine For Lasek  
C#10-180 8 mm p.19



Corneal Trephine For Lasek  
C#10-170 7 mm p.19



Corneal Trephine For Lasek  
C#10-175 7.5 mm p.19



Corneal Trephine For Lasek  
C#10-190 9 mm p.19



Epithelial-Detachment Spatula  
C#10-175-20 p.12



Corneal Trephine For Lasek  
C#10-185 8.5 mm p.19



Tying Forceps 10-0  
Straight, With Micro Platforms  
B#7850 C p.30



Epithelial- Detachment Spatula  
C#10-175-10 p.11

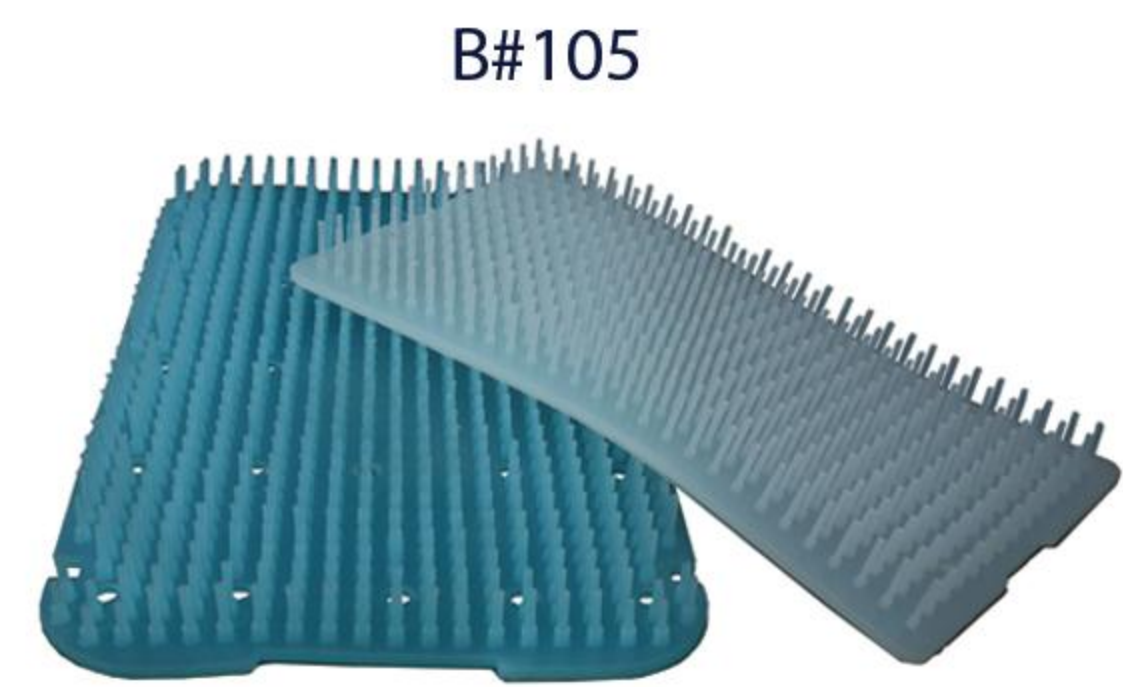

B#105

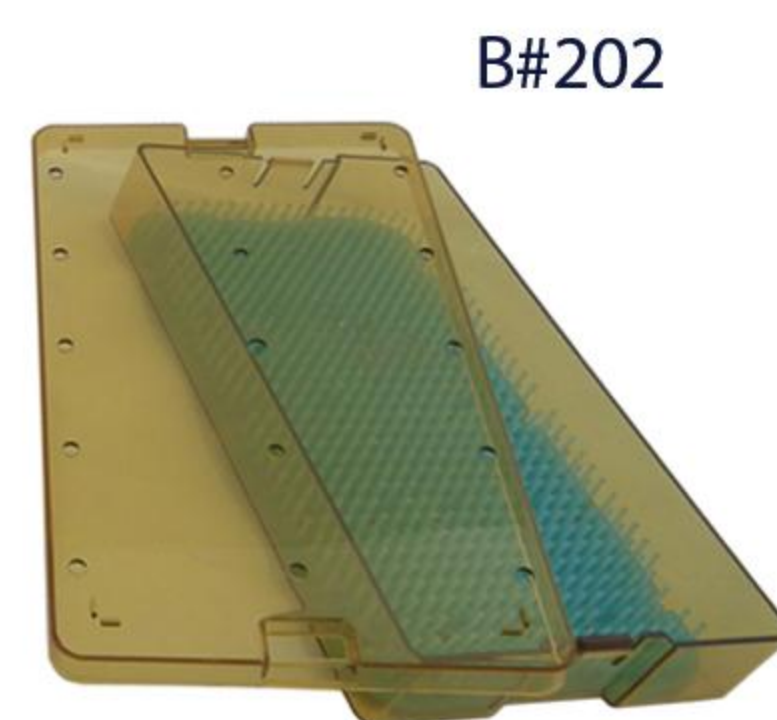

B#202

Mc Pherson Forceps  
B#13242 p.33



BINA® INSTRUMENTS

SURGICAL SETS



## Chalazion Surgical Set

Chalazion Forceps  
B#2131 p.36



Chalazion Forceps  
B#2125 p.36



Eye Scissor  
Curve Blade With Pointed Tips  
B#4878 p.42



Chalazion Curette p.37  
B#40-451 Small  
B#40-452 Medium  
B#40-453 Large



Fixation Forceps 1\*2 teeth  
B#3225 p.30



Vannas Scissors  
Curve Pointed, Blades 5 mm×0.5 mm  
B#9601 p.44



Tying Forceps 10-0  
Straight, with micro platforms  
B#7850C p.30



Scalpel Handle  
B#5500 p.66

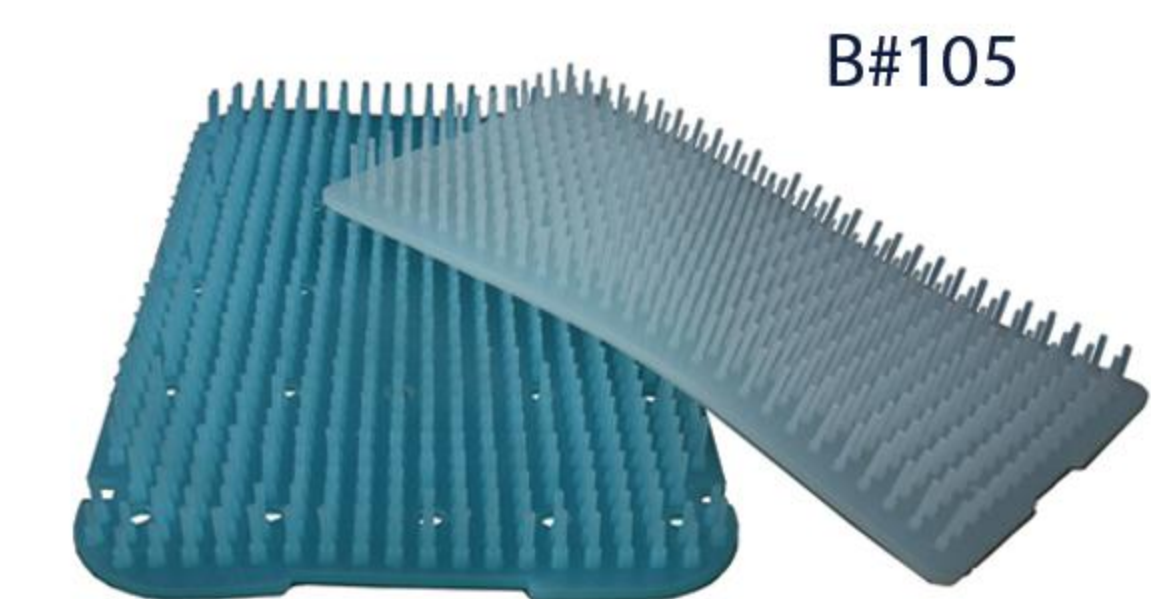

B#105

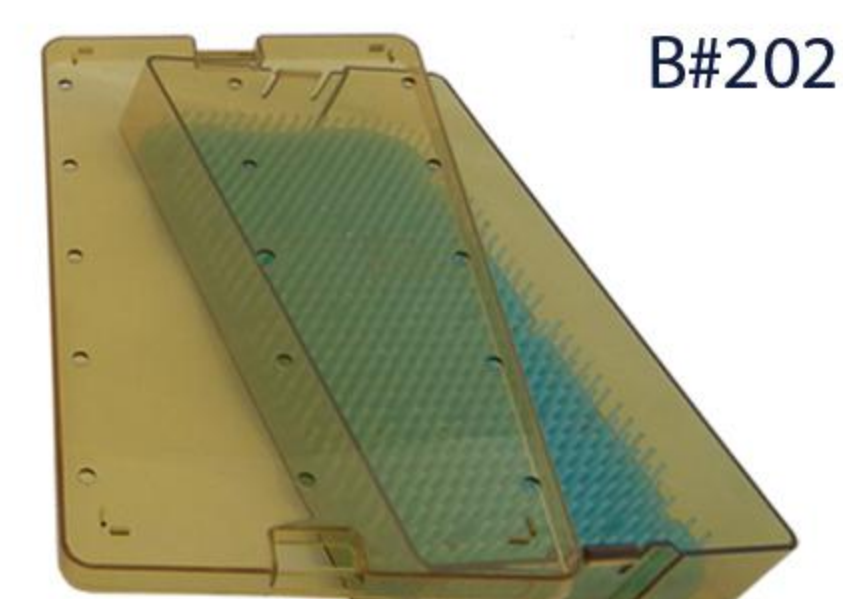

B#202

Barraquer-De Laage Needle Holder  
B#7251 p.40



## Pterigium Surgical Set

Tying Forceps 10-0  
Straight, with micro platforms  
B#7850C p.30



Liberman Lid Speculum (K-wire)  
B#60-300 p.48



Vannas Scissors  
Straight Pointed, Blades 5 mm × 0.5 mm  
B#9600 p.44



Eye Scissor  
Straight Blade With Pointed Tips  
B#4877 p.45



Castroviejo Forceps  
Tying Platform  
B#3045 p.33



Fixation Forceps 1\*2 teeth  
B#3225 p.30



B#105

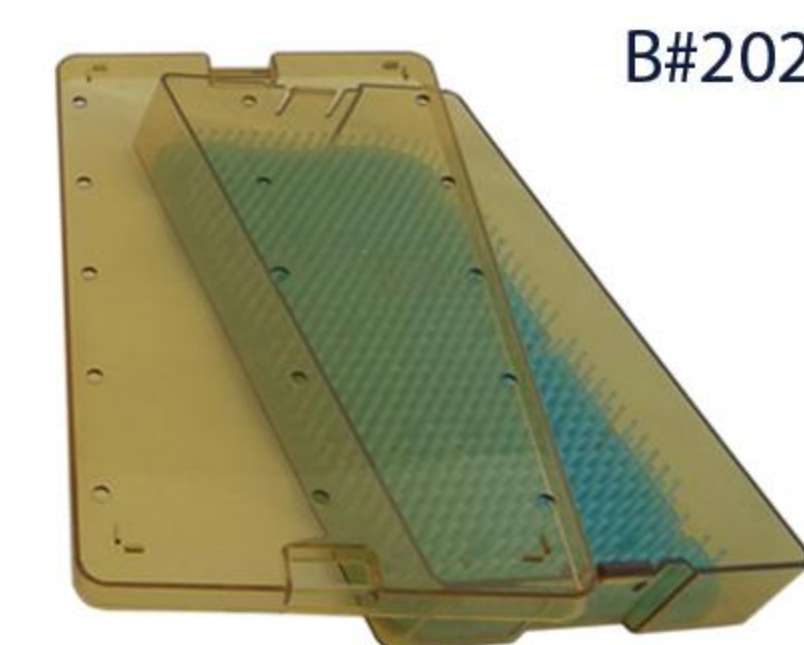

B#202

Barraquer-De Laage Needle Holder  
B#7251 p.40



Lacrimal Irrigating Canuula  
B#40-280 p.5  
Mc Intyre lachrymal probing  
B#40-100 p.5



Bowman Lachrymal Probe  
B#40-230  
B#40-330 p.51  
B#40-430



Lachrymal Dilator  
B#40-500 p.51

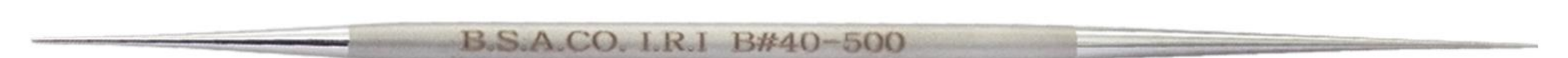

## VitreoRetinal Set

## Surgical Set

جراحی  
ست

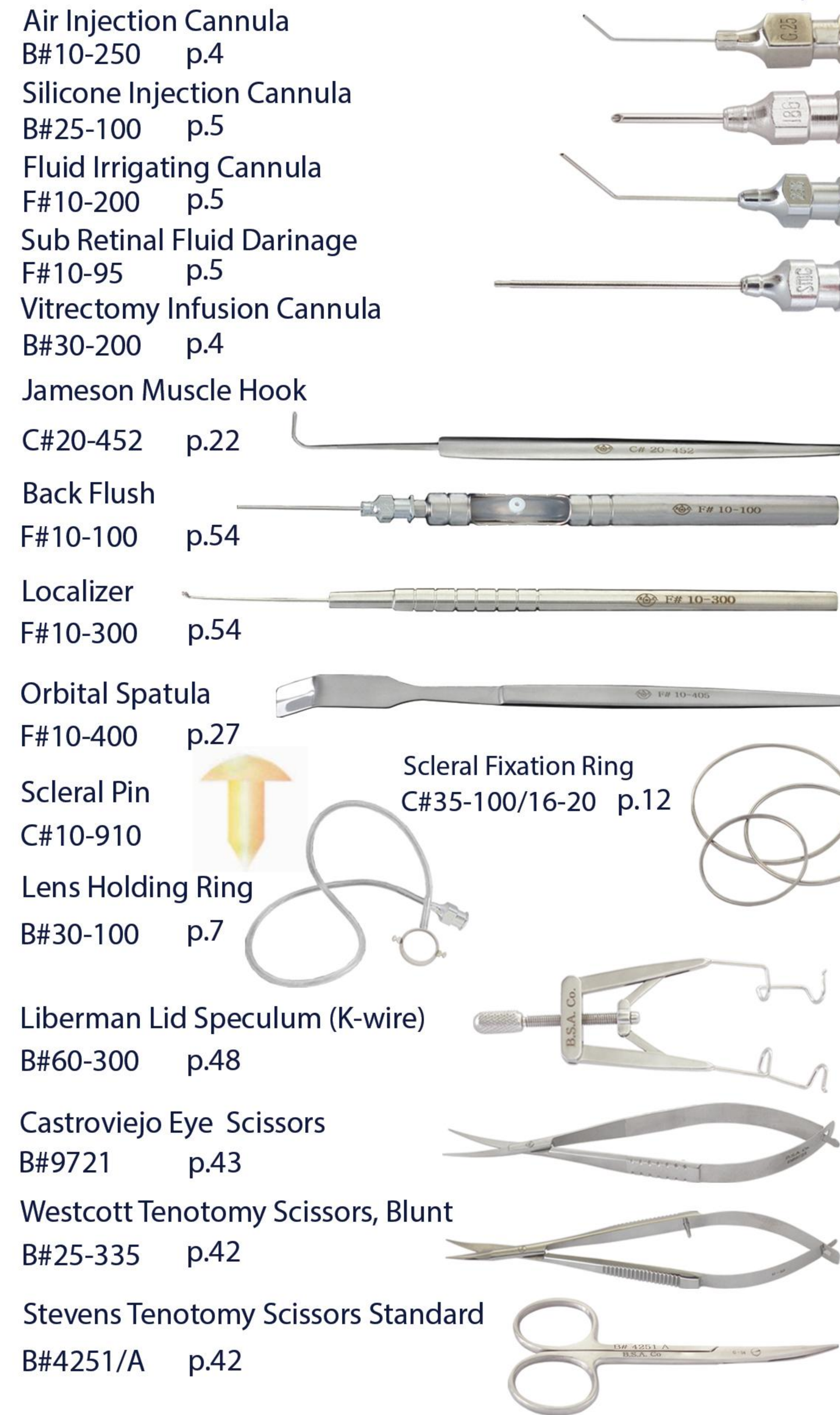

Scleral Depressor  
F#10-350 p.55  
Membrane Spatula  
B#10-450 p.13  
Tying Forceps 10-0  
B#7850 p.30  
Castroviejo Needle Holder 8-0  
B#8148 p.60  
Marking Caliper  
B#8232 p.45  
Eye Scissors  
B#4877 p.32  
Jameson Muscle Hook  
C#20-450 p.21  
Retinal Detachment Hook  
C#20-450-10 p.21  
Barraquer- Troutman Forceps  
B#7862 p.34  
Castroviejo Forceps  
B#7348 p.31  
Fixation Forceps 1\*2 teeth  
B#3225 p.30  
Mc Pherson Forceps  
B#13242 p.33  
Barraquer-De Laage Needle Holder 10-0  
B#7231 p.40

Air Injection Cannula  
B#10-250 p.4  
Silicone Injection Cannula  
B#25-100 p.5  
Fluid Irrigating Cannula  
F#10-200 p.5  
Sub Retinal Fluid Drainage  
F#10-95 p.5  
Vitrectomy Infusion Cannula  
B#30-200 p.4  
Jameson Muscle Hook  
C#20-452 p.22  
Back Flush  
F#10-100 p.54  
Localizer  
F#10-300 p.54  
Orbital Spatula  
F#10-400 p.27  
Scleral Pin  
C#10-910  
Lens Holding Ring  
B#30-100 p.7  
Liberman Lid Speculum (K-wire)  
B#60-300 p.48  
Castroviejo Eye Scissors  
B#9721 p.43  
Westcott Tenotomy Scissors, Blunt  
B#25-335 p.42  
Stevens Tenotomy Scissors Standard  
B#4251/A p.42

## Glaucoma Set

## Surgical Set

جراحی  
ست

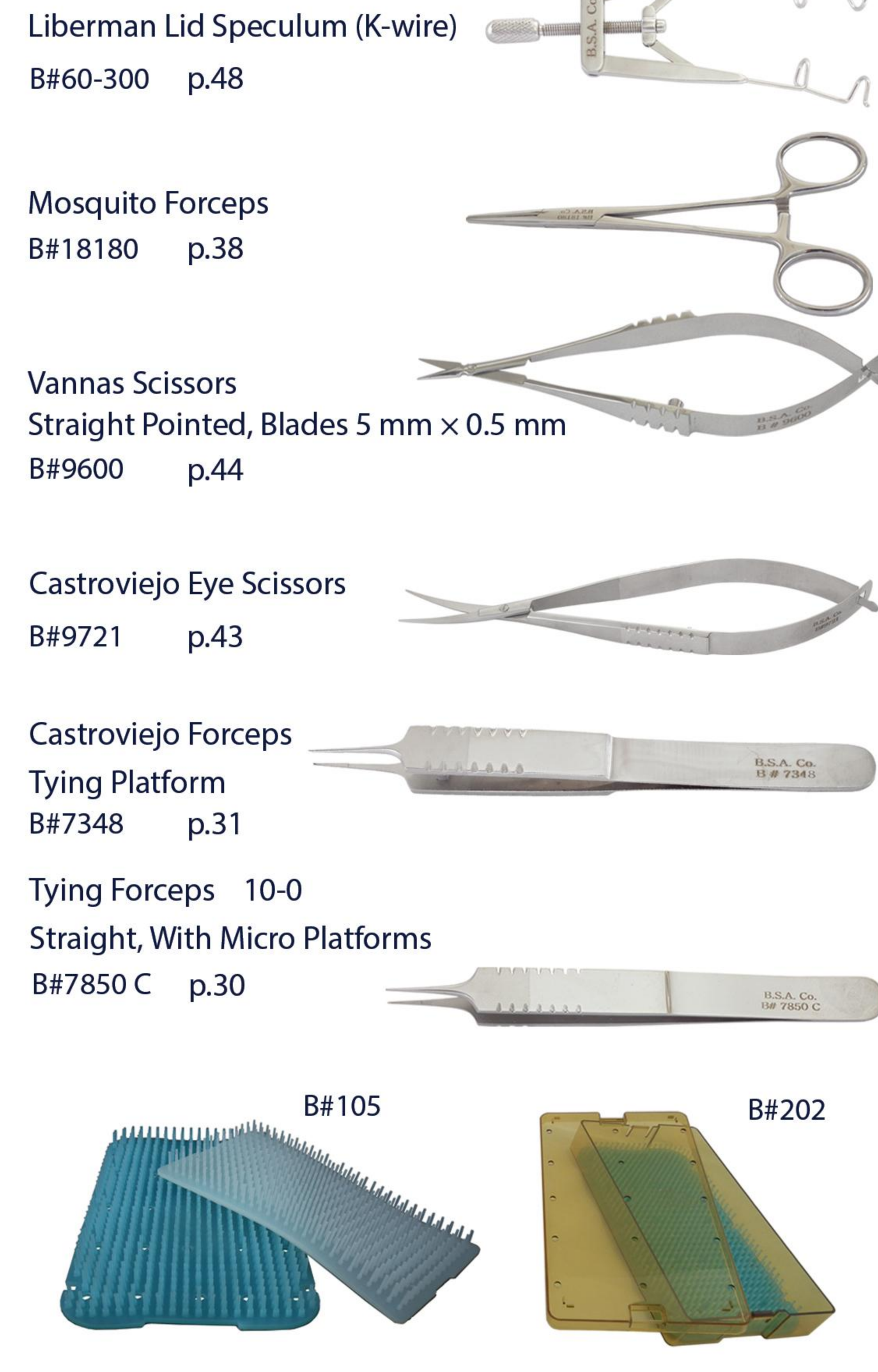

Eye Speculum  
B#60-100 p.47  
Eye Scissors  
Straight Blade With Pointed Tips  
B#4877 p.45  
Westcott Tenotomy Scissors, Blunt  
B#25-335 p.42  
Fixation Forceps 1\*2 teeth  
B#3225 p.34  
Barraquer- Troutman Forceps  
With Tying Platforms  
B#7862 p.34  
Barraquer-De Laage Needle Holder 10-0  
B#7251 p.40  
Air Injection Cannula  
B#10-270 p.4  
Marking Caliper  
B#8232 p.60

Liberman Lid Speculum (K-wire)  
B#60-300 p.48  
Mosquito Forceps  
B#18180 p.38  
Vannas Scissors  
Straight Pointed, Blades 5 mm x 0.5 mm  
B#9600 p.44  
Castroviejo Eye Scissors  
B#9721 p.43  
Castroviejo Forceps  
Tying Platform  
B#7348 p.31  
Tying Forceps 10-0  
Straight, With Micro Platforms  
B#7850 C p.30

## Cataract Set

## Surgical Set

ست جراحی

Phaco Chopper C# 20-200 90° p.57		Liberan Lid Speculum (K-wire) B# 60-300 p.48	
Phaco Spatula C# 10-160 p.11		Barraquer - De Laage Needle Holder 10-0 B#7251 p.40	
Lens Loop C# 10-350 p.62		Castroviejo Needle Holder 8-0 B#8148 p.40	
Jameson Muscle Hook C# 20-452 p.22		Eye Scissors B#4878 p.42	
Tying Forceps 10-0 B# 7850 C p.30		Westcott Tenotomy Scissors, Blunt B#25-335 p.42	
Tying Forceps 8-0 B# 2432 p.30		Castroviejo Eye Scissors B#9721 p.43	
Mc Pherson Forceps B#13242 p.33		Vannas Scissors B#9601 p.44	
Castroviejo Forceps B# 7348 p.31		Nucleus Hydro Dissection Cannula B#15-255 p.4	
Castroviejo Forceps B# 3045 p.33		Air Injection Cannula B#10-250 p.4	
Fixation Forceps 1*2 teeth B# 3225 p.34		Posterior Extractor & Capsule Polisher B#10-170 p.6	
Barraquer- Troutman Forceps B#7862 p.34		Capsulorhexis Forceps B# 18259 p.32	
Double I / A Cannula Original B#20-110 p.4		Iris Spatula C#10-150 p.10	
Self-Retaining Anterior Chamber B#30-310 p.7		Lens Manipulator and Iris Hook C#10-130 p.25	
Simcoe B#22-200 p.6		Eye Cautery C#10-300 p.24	
Globe Fixation Ring C#10-165 p.17		"Y" Hook Lens Manipulator C#10-140 p.23	
Akahoshi Phaco PreChopper B#AS-130 p.32			
Bimanual Hand Pieces (Phaco) F#10-150 p.8			
Micro Iris Hook C#10-135 p.25			
Iris Retractor C#10-135 A p.28			

## D.C.R Set

## Surgical Set

ست جراحی

Jaeger Lid Plate B# 40-545 p.28		Lachrymal Irrigating Cannula B#40-280 p.4	
Lachrymal Retractor B# 40-150 p.27		Mc Intyre Lachrymal Probing Cannula B# 40-200 p.5	
Castroviejo Needle Holder 8-0 B# 8148 p.40		Mc Intyre Lachrymal Probing Cannula B# 40-100 p.5	
Eye Scissors B#4878 p.42		Jameson Muscle Hook C# 20-452 p.22	
D.C.R Rongeur B#1380 p.65		Desmarres F#10-410 p.27	
	 B#105	Suction Tube B# 80-80 p.63	
	 B#202	Lachrymal Dilator B# 40-500 p.51	
Tying Forceps 8-0 B# 2432 p.30		Bowman Lachrymal Probe B# 40-230 p.51	
Fixation Forceps 1*2 teeth B# 3225 p.34		B# 40-330	
		B# 40-430	
Barraquer - De Laage Needle Holder B# 7251 p.40		Bodkin	
Stevens Tenotomy Scissors Standard B# 4251A p.42		Crawford	
Pigtail Hook B# 40-480 p.25		Crawford Retrieving Hook B# 40-600 p.52	
		Mallet B# 40-700 p.64	

## Corneal Transplantation Set

Surgical Set

ست جراحی

Fixation Forceps 1\*2 teeth  
B# 3225 p.34



Liberman Speculum  
B# 60-320 p.48



Castroviejo Forceps  
B# 3045 p.33



Barraquer-Troutman Forceps  
B# 7862 p.34



Scleral Fixation Ring  
C#35-100 p.17



Tying Forceps 10-0  
B# 7850 C p.30



Eye Speculum  
B# 60-100 p.47



Tying Forceps 10-0  
B# 13168 p.30



Iris Spatula  
C# 10-150-1 p.10



Mosquito Forceps  
B# 18180 p.38



Castroviejo Needle Holder 8-0  
B# 8148 p.40



Castroviejo Corneal Section Scissors  
Counter Clockwise  
B# 80-23 A



Barraquer - De Laage Needle Holder 10-0  
B# 7251 p.40



Castroviejo Corneal Section Scissors  
Clockwise  
B# 80-23 B p.44



Air Injection Cannula  
B# 10-250 p.4



Westcott Tenotomy Scissors, Blunt  
B# 25-335 p.42



Castroviejo Forceps  
B# 7348 p.31



Castroviejo Eye Scissors  
B# 9721 p.43



Marking Caliper  
B# 8232 p.60

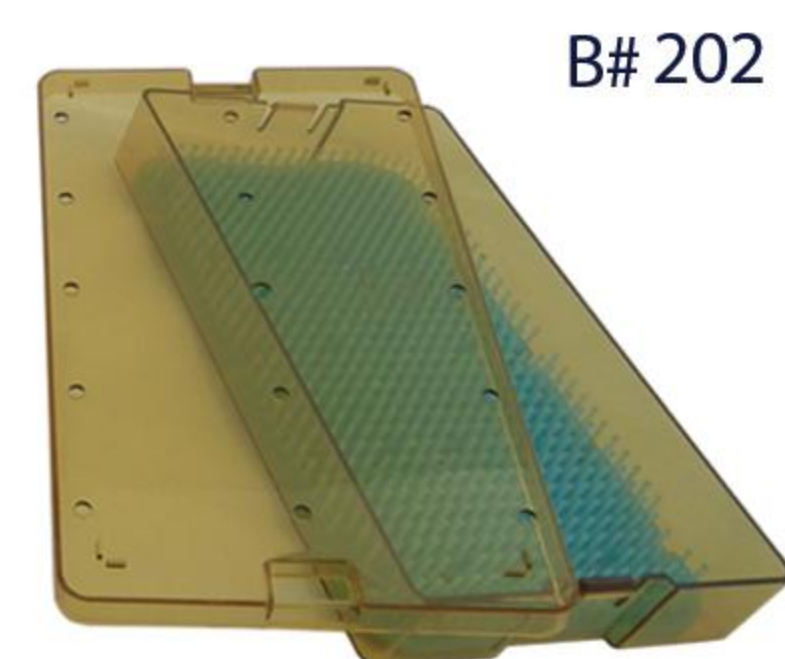
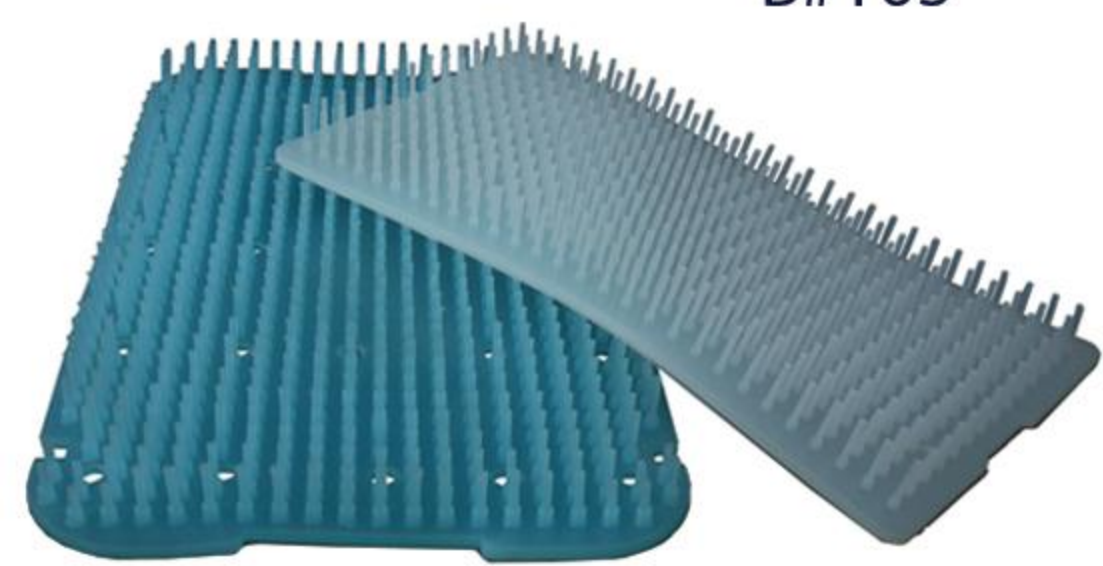

76

## Phaco Set

Surgical Set

ست جراحی

Phaco Chopper  
C# 20-200 90° p.57



Liberman Lid Speculum (K-wire)  
B# 60-300 p.48



Phaco Spatula  
C#10-160 p.11



Barraquer-De Laage Needle Holder 10-0  
B# 7251 p.40



Lens Loop  
C#10-350 p.62



Castroviejo Needle Holder 8-0  
B# 8148 p.40



Tying Forceps 10-0  
B# 7850 p.30



Westcott Tenotomy Scissors, Blunt  
B# 25-335 p.42



Mc Pherson Forceps  
B# 13242 p.33



Castroviejo Eye Scissors  
B# 9721 p.43



Castroviejo Forceps  
B# 3045 p.33



Vannas Scissors  
B# 9601 p.44



Fixation Forceps 1\*2 teeth  
B# 3225 p.34



Air Injection Cannula  
B# 10-270 p.4



Barraquer-Troutman Forceps  
B# 7862 p.34



Nucleus Hydro Dissection Cannula  
B# 15-255 p.4



Jensen  
B#10-150 p.5



Double I / A Cannula Original  
B# 20-110 p.4



Capsulorhexis Forceps  
B# 18259 p.32



Iris Spatula  
C#10-150 p.10



Sinsky  
C#10-120 p.24



Lens Manipulator and Iris Hook  
C#10-130 p.25

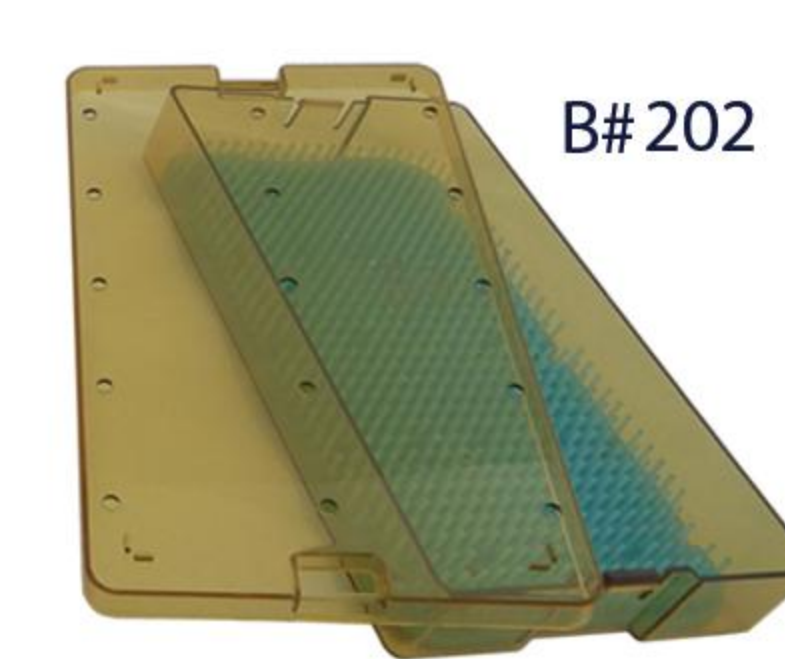

75

## Strabism Set

## Surgical Set

ست جراحی

Fixation Forceps 1\*2 teeth  
B#3225 p.34



Lieberman Speculum  
B#60-320 p.48



Barraquer - De Laage Needle Holder 10-0  
B#7251 p.40



Air Injection Cannula  
B#10-230 p.4



Castroviejo Needle Holder 8-0  
B#8148 p.40



Jameson Muscle Hook  
C#20-451 p.22



Marking Caliper  
B#8232 p.60



C#20-452 p.22



Mosquito Forceps  
B#18180 p.38



C#20-453 p.22



Westcott Tenotomy Scissors, Blunt  
B#25-335 p.42



Oblique Muscle Hook  
C#20-450-20 p.21



Eye Scissors  
B#4877 p.45



Small Incision Muscle Hook  
C#20-480 p.22



Stevens Tenotomy Scissors  
B#18013 p.42



Malbran Muscle Hook  
C#20-450-30 p.22



Desmarres  
F#10-411 p.27



Orbital Spatula  
F#10-400 p.27



Tying Forceps 8-0  
B#2432 p.30

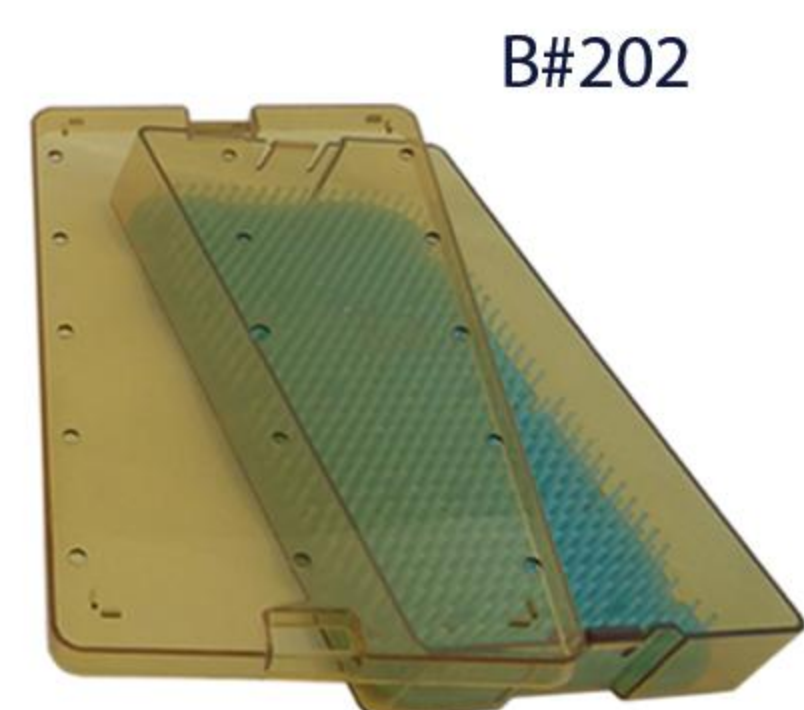
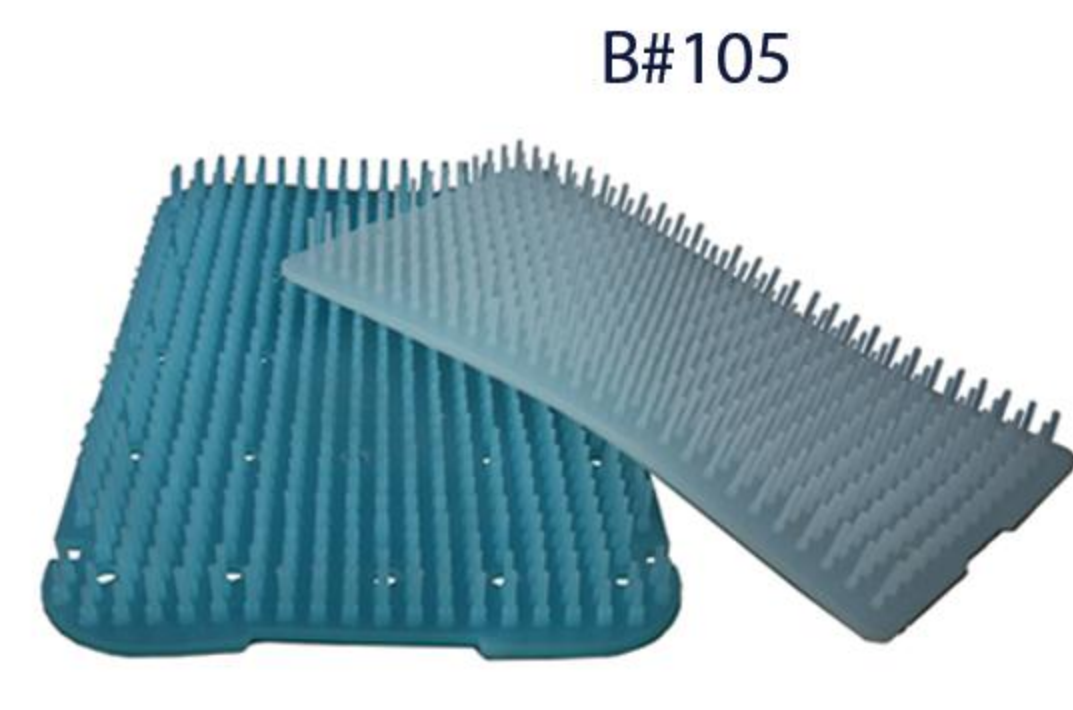

78

## Orbit Set

## Surgical Set

ست جراحی

Marking Caliper  
B#8232 p.60



Air Injection Cannula  
B#10-230 p.4



Westcott Tenotomy Scissors, Blunt  
B#25-335 p.42



Jameson Muscle Hook  
C#20-452 p.22



Stevens Tenotomy Scissors Standard  
B#4251 A p.42



Jaeger Lid Plate  
B#40-545 p.28



Stevens Tenotomy Scissors  
B#18013 p.42



Lachrymal Retractor  
B#40-150 p.27



Eye Scissors  
B#4877 p.45



Desmarres  
F#10-411 p.27



Mosquito Forceps  
B#18180 p.38



Tying Forceps 8-0  
B#2432 p.30



Stainless Steel Eye Shield  
Normal B#40-525  
Handle B#40-525 H p.65



Tying Forceps 10-0  
B#7850 C p.30



Ilif Wright Fascia Needle  
B#40-510 p.63



Barraquer - De Laage Needle Holder 10-0  
B#7251 p.40



Castroviejo Forceps  
B#7348 p.31



B#105

B#202

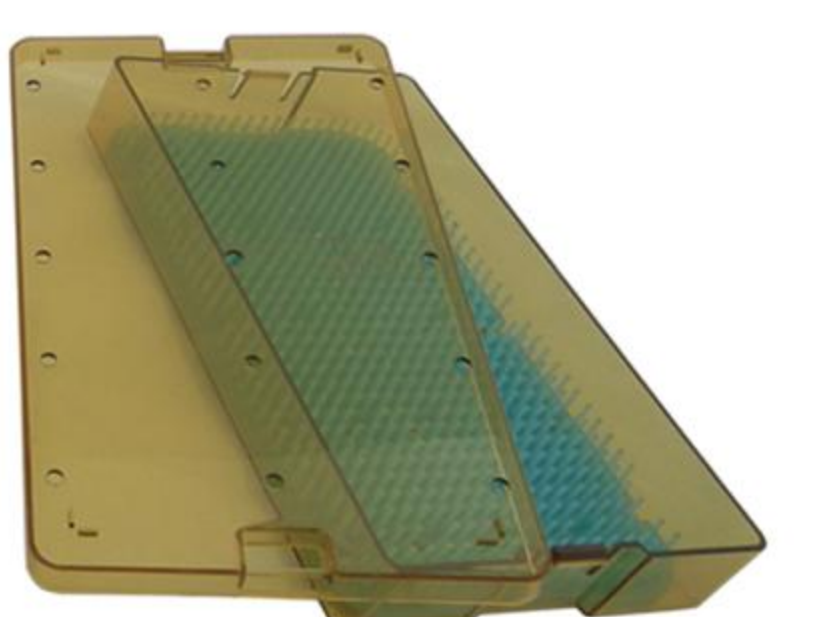
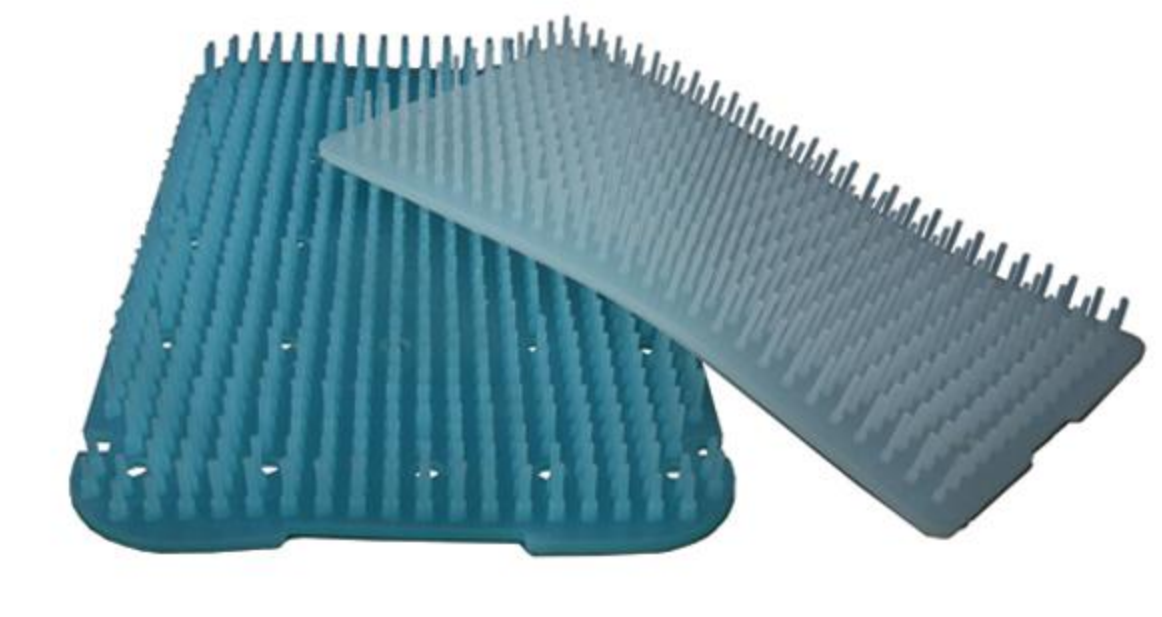

77

# BINA® INSTRUMENTS

## MAINTENANCE OF OPHTHALMIC SURGICAL INSTRUMENTS

### Probing Set

Surgical Set

Bowman Lachrymal Probe  
Cylindrical Tip, Malleable S.Steel  
B#40-230  
B#40-330  
B#40-430

p.51

Lachrymal Dilator  
B#40-500

p.51

Lachrymal Irrigating Cannula  
B#40-280

p.4

Mc Intyre lachrymal probing Cannula  
B#40-100 G.22 50mm  
B#40-200 G.23 50mm

p.5





## Maintenance Of Ophthalmic Surgical Instruments

- در تمیزکاری با استفاده از ماشین، تمام رسوبات حاصل از تمیزکاری باید به طور اطمینان بخشی در مرحله آبکشی خارج شود. در غیر این صورت بر روی وسایل لکه باقی مانده و یا تغییر رنگ ایجاد می شود. استفاده از یک خنثی کننده مناسب می تواند نتایج آبکشی را بهبود بخشد.
- برای تمیز کردن و ضدعفونی ابزارهای جراحی در هنگام شستشو آنها را به حالت باز قرار دهید و از قراردادن آنها در محلولهای پاک کننده به مدت طولانی جداً خودداری کنید.
- برای تمیز کردن ابزارها با استفاده از دستگاه فراصوت، وسایل جراحی در سبدهای مخصوص استریلیزه کردن به طور باز قرار می گیرند. از آنجا که آب خالص گرم بدون افزودنی، نتایج رضایت بخشی به وجود نمی آورد، باید یک شوینده مناسب به آب اضافه شود.
- دمای محلول شوینده باید بین ۴۰ تا ۴۵ درجه سانتیگراد باشد. ( اگر این دما کم شود تأثیر آب تضمین نمی شود و اگر از این دما بیشتر شود ، پروتئین احتمالی باقی مانده از نسوج ممکن است لخته شود.) بعد از تمیز کردن با دستگاه فراصوت باید وسیله به طور کامل به وسیله ماشین و یا دستی آبکشی شده و سپس بلافاصله به طور کامل خشک شود.
- برای روانکاری وسایل در محل مفاصل و اتصالات آنها از روان کننده استفاده می شود. روانکاری دستی می تواند به صورت اسپری نمودن و یا استفاده مستقیم از روانکارهایی مانند پارافین برای مفاصل باشد. روانکارها باید از ترکیباتی ساخته شوند که عاری از تأثیرات فیزیولوژیکی بوده و در محل مفاصل و اتصالات ایجاد چسبندگی نکنند.
- قبل از مرحله استریل کردن، ابزارهایی که دارای ضامن هستند بسته شوند و از ایجاد فشار و تنش در حالت سرد و گرم شدن جلوگیری شود.
- وجود کلر و املاح موجود در آب می تواند در ابزارهای جراحی به خصوص در مفاصل خوردگی ایجاد نماید. در صورتی که رسوبات باقیمانده پس از آبکشی و ضدعفونی از روی ابزارها پاک نشود، با گذشت زمان خوردگی در این محل ها افزایش مییابد. حرارت زیاد در هنگام استریلیزاسیون این آسیب را تشدید می کند. وجود املاح در آب می تواند باعث تغییر رنگ سطح ابزار و خوردگی آنها و در نتیجه کاهش عمر مفید آنها شود.
- معمولاً زنگ زدگی در محل اتصالات و مفاصل و جاهایی که بیشتر در تماس با یکدیگر می باشند ایجاد می شود. با تمیز کردن آنها به روش صحیح و روغن کاری از زنگ زدگی ابزارهای جراحی جلوگیری نمایید.
- ابزارهای جراحی بسیار حساس و آسیب پذیر هستند. از ضربه زدن و از روی هم قرار دادن و تماس ابزار با یکدیگر خودداری نمایید. عدم توجه به این موضوع موجب ایجاد خراشیدگی در پوشش ابزار شده و به میزان زیادی از عمر آن می کاهد.
- پس از تمیز کاری و استریل نمودن ابزارها، آنها را در لفاف ها و یا پوشش مناسب قرار داده و در محل مخصوص نگهداری نمایید. از قرار دادن ابزارهای جراحی در محل های مرطوب و یا در مسیر گاز های شیمیایی به طور جدی خودداری نمایید.



## Maintenance Of Ophthalmic Surgical Instruments

## نگهداری و مراقبت از ابزارهای جراحی

ابزارهای جراحی با توجه به تنوع و کاربرد آنها در بخش های مختلف پزشکی از اهمیت بسیاری برخوردار می باشند. خرید ابزارهای جراحی قسمت مهمی از هزینه های بخش های پزشکی را تشکیل می دهد. نحوه خرید و انتخاب مناسب این ابزارها، نگهداری و آماده سازی آنها به روش صحیح می تواند باعث کاهش استهلاک و افزایش عمر وسیله و در نتیجه صرفه جویی در هزینه های پزشکی شود.

ابزارهای جراحی در اثر یک یا چند عامل زیر می توانند آسیب دیده و عمر کوتاهی داشته باشند:

- شستشوی نامناسب با وسایل تیز و خراش دهنده مانند برس سیمی و یا سیم ظرفشویی
- تأثیر آب مورد استفاده و رسوبات باقی مانده در ابزارها، ناشی از املاح موجود در آب
- عدم رعایت اصول و شرایط مناسب در هنگام تمیزکاری و استریلیزاسیون و روغنکاری
- عدم استفاده از محلولهای پاک کننده شوینده و ضدعفونی کننده مناسب
- عدم رعایت اصول جابجایی و نگهداری ابزارها
- در نهایت کیفیت نامناسب در ساخت ابزار و عدم استفاده از مواد اولیه با کیفیت بالا

## نگهداری و آماده سازی ابزارهای جراحی

- پس از هر بار استفاده از ابزار جراحی بلافاصله باید آن را تمیز کرده و برای استفاده بعدی آماده نمود. تمیز کردن ابزارها شامل شستشو، ضدعفونی و استریل کردن می باشد. باید توجه داشت استریل نمودن ابزارهای جراحی به تنهایی به معنی تمیز کردن آنها نمی باشد.
- جدا از کیفیت آب آشامیدنی، وجود املاح و مواد مختلف مانند کلر با توجه به غلظت های آنها ممکن است باعث آسیب رساندن به وسایل جراحی و خوردگی آنها شود. برای جلوگیری از خوردگی، استفاده از آب مقطر توصیه می شود.
- از مواد شوینده و ضدعفونی کننده مناسب جهت تمیز کردن ابزارها استفاده شود. محلول های مورد استفاده برای تمیز کردن و ضدعفونی کردن دستی ابزارها نباید بالاتر از دمای اتاق گرم شوند. محلول های شستشو و ضدعفونی باید به میزان مورد نیاز به طور روزانه تهیه و همواره تازه باشند. میزان غلظت محلول و زمان تأثیرگذاری آن براساس اطلاعات سازنده، تهیه و دقیقاً رعایت شود.
- در صورتی که از پودرهای مخصوص استفاده می شود، ابتدا محلول به میزان مورد نیاز از پودر و آب تهیه شده و سپس ابزارها در داخل محلول قرار بگیرند. برای ابزارهایی که از جنس فلزات سبک و فلزات غیر آهنی هستند محلولهای مخصوص به کار ببرید.
- ابزارها را بعد از ضدعفونی کردن، کاملاً با آب تمیز و جاری (بدون رسوب) آبکشی نمایید. برای جلوگیری از بقایای لکه های چربی در مرحله تمیزکاری، آبکشی را با آب جاری ۴۵ درجه انجام دهید. نتایج رضایت بخش در مورد حداقل خوردگی ماده، تنها وقتی حاصل می شود که مقدار کافی و مناسب از محلول استفاده شود.

جهت دریافت اطلاعات جامع در مورد نحوه نگهداری اصولی از ابزارهای جراحی به سایت شرکت مراجعه نموده و یا با واحد روابط عمومی تماس حاصل فرمایید.

شرکت بینا ساز ابزار





BINA SAZ ABZAR

Surgical Instruments Manufacturer

[WWW.BINASAZ.COM](http://WWW.BINASAZ.COM)

تهران-خیابان کلهر-بعد از تقاطع اسکندری جنوبی-پلاک ۱۷۰  
کد پستی:  
۱۳۱۱۶۳۴۸۱۱  
تلفن: ۰۲۱-۶۶۹۰۱۴۰۷  
۰۲۱-۶۶۴۳۳۳۲۷